

The radio... **YAESU**

HF&V/UHF ALL MODE TRANSCEIVERS

Product Catalog



Inherent Passion and Inspiration

Creating the Future of HF communications

Birth of the FT DX101

True Performance

Hybrid SDRs (Narrow Band SDR & Direct Sampling SDR)

2kHz RMDR 123dB+

2kHz BDR 150dB+

2kHz 3rd IMDR 110dB+

400MHz HRDDS (High Resolution Direct Digital Synthesizer)

2kHz Phase Noise $-150\text{dBc}/\text{Hz}$

VC-TUNE (Variable Capacitor Tune) signal peaking

3DSS (3-Dimensional Spectrum Stream) visual display



The Conclusive Choice

Offering True RF Performance & Exciting New Features



HF/50 MHz Transceiver

FTDX 101MP 200 W

- External Power Supply with 100mm (3.94") Front Facing Speaker: FPS-101 included
- VC-Tune unit x 2 (MAIN and SUB bands) included
- 300 Hz Crystal Roofing Filter (MAIN band) included
- 600 Hz Crystal Roofing Filter (MAIN and SUB bands) included
- 3 kHz Crystal Roofing Filter (MAIN and SUB bands) included

FTDX101MP: As of April 2019, this device has not been approved by the FCC. It may not be offered for sale or lease, or be sold or leased until FCC approval has been obtained. The information shown is preliminary and may be subject to change without notice or obligation.

Supplied Accessories

FTDX101MP:

- External Power Supply with Speaker: FPS-101
- Hand Microphone SSM-75G

FTDX101D:

- DC Power cable
- Hand Microphone SSM-75G

Optional Accessories

- 
 - SP-101 External Speaker
 - Audio Output: 7 Watts
 - Impedance: 8 ohms
 - Speaker diameter: 100 mm
 - Size (WxHxD): 6.30" x 5.12" x 12.68" (160 x 130 x 322 mm)
 - Weight (approx.): 4.41 lbs (2 kg)

- 
 - M-1 Reference Microphone
 - Revolutionary dual microphone configuration
 - Nine-band graphic equalizer
 - Treble Boost Cowling produces a unique tonal texture to the transmitted audio



HF/50 MHz Transceiver

FTDX 101D 100 W

- VC-Tune unit (MAIN band) included *For VC-Tune SUB band unit installation, please contact YAESU
- 600Hz Crystal Roofing Filter (MAIN and SUB bands) included
- 3kHz Crystal Roofing Filter (MAIN and SUB bands) included

Narrow Band SDR

Crystal Roofing Filters Enable Phenomenal Multi-signal receiving characteristics

The Down Conversion type receiver configuration is similar to the FTDX5000. With a low noise figure dual gate MOS FET, D-quad DBM (Double Balanced Mixer) with excellent intermodulation characteristics. Narrow band SDR configuration with the first IF at 9MHz makes it possible to have excellent narrow bandwidth

crystal roofing filters that have the desired sharp cliff edge shape factor. These high quality roofing filters enable the amazing multi-signal receiving performance demanded when faced with the most challenging on-the-air interference situations.

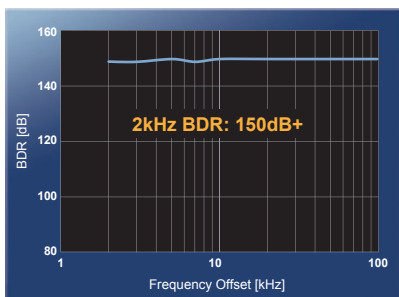

■ 14MHz Band Blocking Dynamic Range (BDR)

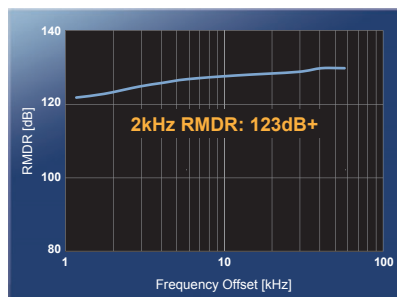

■ 14MHz Band Reciprocal Mixing Dynamic Range (RMDR)

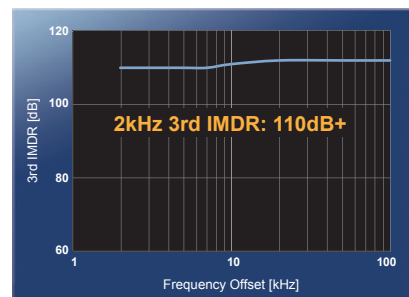

■ 3rd IM Dynamic Range (IMDR)

Hybrid SDR (Narrow band SDR & Direct Sampling SDR)

© Emphasizes Excellent Receiver Performance and Hybrid SDR Functionality Digital Processing Generated Real-Time Spectrum Scope

The FT DX 101 series uses a hybrid SDR configuration that integrates a direct sampling SDR receiver in order to view the entire band status in real time, with the excellent dynamic receiver performance achieved by the narrow band SDR receiver circuit. The Direct Sampling SDR driving the real time Spectrum display with its large dynamic range enables the weakest signal to be observed on the display when it appears and the Narrow Band SDR enables that signal to be selected,

filtered and then decoded. If there is powerful AM station near your location or in challenging operating situations where there are a lot of strong signals in the band from Contests, DX-pedition activities, those signals outside the passband are attenuated by the very effective roofing filter at the front stage of the A/D converter. Therefore, interference is reduced making it is possible to continue to operate even under such difficult conditions.

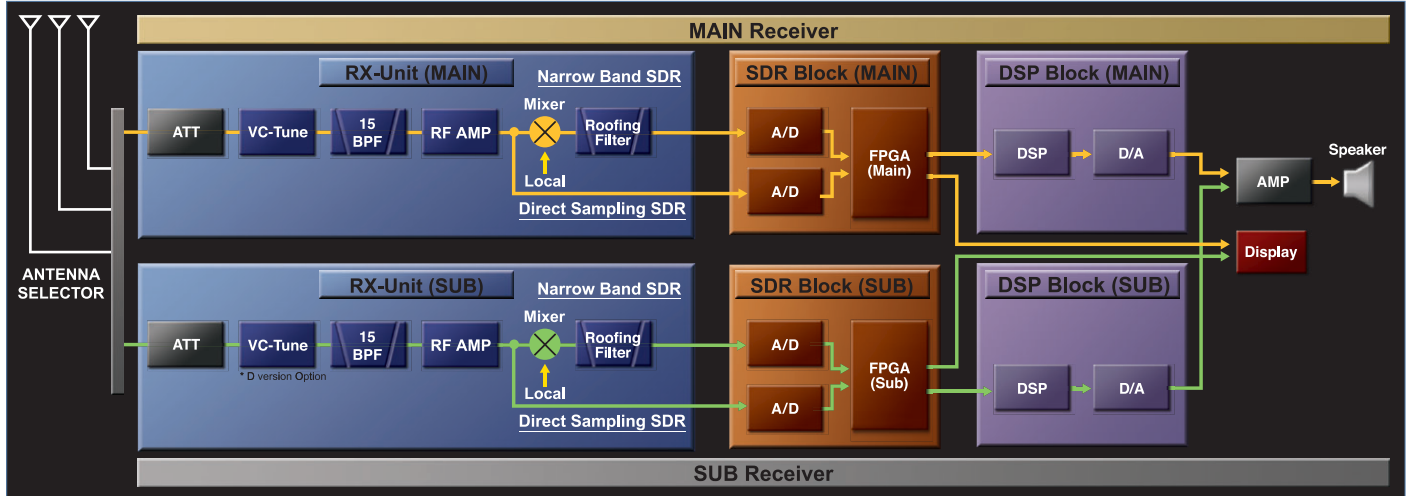

■ Completely Independent Dual Hybrid SDR

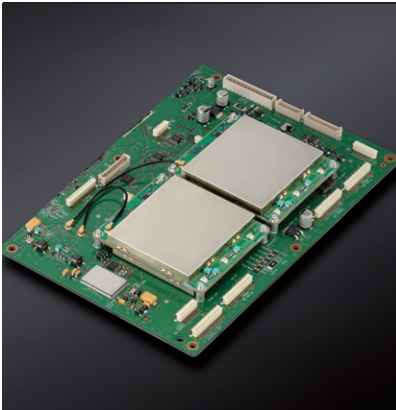

■ 400MHz HRDDS Unit

Ultra Low-Noise Local Oscillator System; 400MHz HRDDS (High Resolution Direct Digital Synthesizer)

The local circuit of the FT DX 101 uses the 400 MHz HRDDS method. This circuit configuration generates a local signal by directly dividing from a high frequency of 400 MHz, the theoretical PLL lockup time becomes zero, and C/N deterioration by the lockup time does not occur. The significantly improvement of the C/N characteristic by directly dividing the frequency down contributes dramatically to reducing the noise in the entire receiver stage, and so improves the BDR (Blocking Dynamic Range) close-in performance. In the FTDX 101 series, the 400 MHz HRDDS latest design characteristics and the careful selection of the components used in the design results in the phase noise characteristic of the local signal that achieves an excellent value of -150dBc/Hz at 2kHz separation.

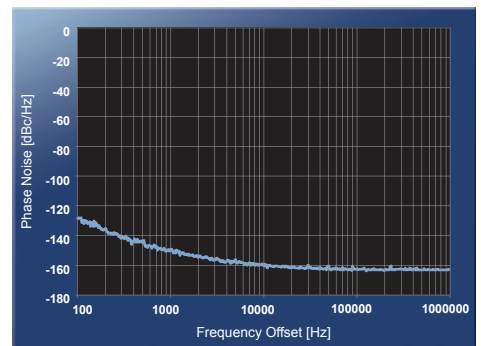

■ 1st Local OSC Phase Noise (14.2 MHz)

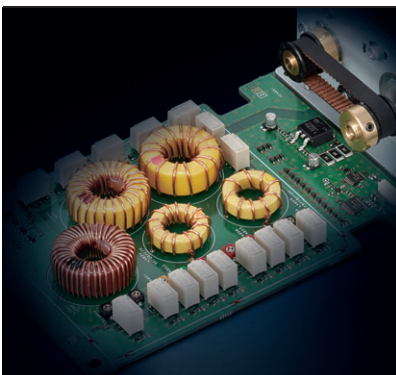

■ VC-Tune RF Preselector

Automatic RF Preselector VC-Tune with a high precision stepping motor

In the FT DX 101 series, a next-generation RF preselector VC-Tune design further improves the high performance RF μ Tuning system, by using a remarkable miniaturization design while producing an unparalleled attenuation characteristic of maximum attenuation -70 dB. A high precision stepping motor drives a variable capacitor (VC) to continuously cover the band as it follows the tuning by the operator. Fine-tuning for optimum improvement point is also available by using the MPVD (Multi-Purpose VFO Outer Dial) placed outside the main VFO dial knob.

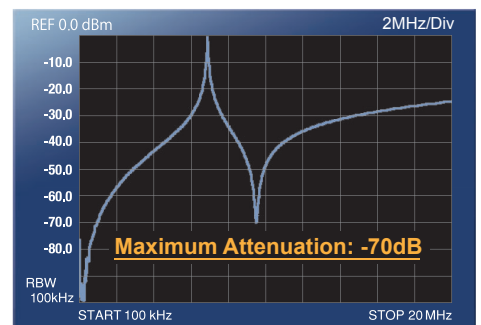

■ VC-Tune (7MHz, Span 20MHz)



■ Transmit Final Stage

Signal Purity

■ High-Quality Transmission with Outstanding Phase noise Characteristics

The excellent C/N characteristics provided by the 400MHz HRDDS (High Resolution Direct Digital Synthesizer) used in the local oscillator circuit also contributes significantly to the transmitter section performance. In the FTDX101, a thorough examination of each element up to the final TX stage was made. The clock-distributor that divides and distributes the local signal from the 400MHz HRDDS circuit to each block, as well as the FPGA, D/A converter, the final power amplifier etc., and carefully selecting the latest circuit configurations to improve the C/N characteristics of the entire transmitter block. The transmit signal is directly generated from a 16-bit D/A converter without passing through a mixer circuit, therefore distortion and noise are significantly suppressed. As a result,

high-quality local signal characteristics are maintained without degradation to the final stage, and the transmission phase noise characteristics achieve -150 dBc/Hz at 2kHz separation.

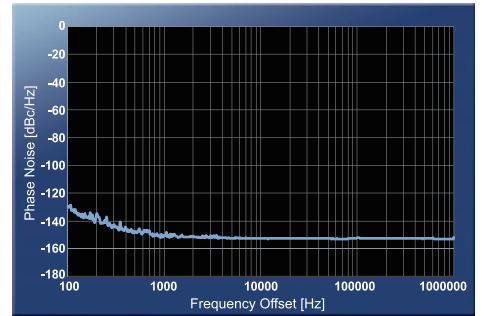

■ TX Phase Noise (14 MHz band, Mode: CW)

New Generation Scope Display 3DSS

■ Intuitively grasp changes in the Strength of the Signals

The 3DSS display is a remarkable completely new system that displays the constantly changing band conditions in three dimensions (3-D) with the frequency as the horizontal axis (X axis), the signal strength as the vertical axis (Y axis), and the time axis as the Z axis. The operator can intuitively view the constant changes in a signal's strength as the signal flows to the back of the screen giving you a sensation of traveling in Time space. The operator can effectively see the close-in QRM situation from the Narrow band SDR output while at the same

time easily observe activity across the whole band from the Direct sampling SDR output.



■ 3DSS Display



■ DUAL/Vertical Display



■ MULTI Display

Front Panel Design Emphasizes Solid Superior Response and Operability

■ ABI (Active Band Indicator)

ABI indicators are arranged as the band select keys in a horizontal row above the VFO dial. When the MAIN Band is selected, the LED indicates in white, and when the SUB Band is selected, the LED indicates in blue. When transmit is keyed, the LED turns red and you can instantly confirm which VFO is transmitting.



■ ABI (Active Band Indicator)

■ MPVD (Multi-Purpose VFO Outer Dial)

The MPVD is a large high-grade aluminum multifunctional ring around the outside of the VFO dial. The ring allows control of SUB VFO frequency dial, VC-TUNE, Clarifier and C/S (custom select function). The MPVD is a handy dial that allows you to adjust important functions in ever-changing HF communications without taking your hand off the VFO.



■ MPVD (Multi-Purpose VFO Outer Dial)

QUADRA SYSTEM

- VL-1000 HF-50MHz 1kW Linear Amplifier* (50MHz; 500W/USA Version) Automatic Antenna Tuner Built In
- VP-1000 VL-1000 Power Supply*
- CT-178 VL-1000 Connection Cable*

- VCT-101 VC-Tune unit FTDX101D (for SUB Band)
- * VC-Tune unit option Please contact Yaesu about installation.
- LAN unit (External type) (Available in near future: as of April 2019)

OPTIONS

<p>● FC-40 Automatic Antenna Tuner (for Long wire antenna)</p>	<p>● FH-2 Remote Control Keypad</p>	<p>● SP-101 External Speaker</p>	<p>● SSM-75G Hand Microphone</p>	<p>● M-100 Dual-Element Microphone</p>	<p>● MD-200A8X Ultra High fidelity Desktop Microphone</p>	<p>● MD-100A8X Desktop Microphone</p>	<p>● YH-77STA Lightweight Stereo Headphone</p>
--	-------------------------------------	----------------------------------	----------------------------------	--	---	---------------------------------------	--

- CW Narrow Filter
 - XF-128CN (MAIN) 9.005 MHz / CW 300 Hz
 - XF-129CN (SUB) 8.900 MHz / CW 300 Hz
- SSB Narrow Filter
 - XF-128SN (MAIN) 9.005 MHz / SSB 1.2 kHz
 - XF-129SN (SUB) 8.900 MHz / SSB 1.2 kHz

* USA and Asian versions only

The Answer ...

Equipped with Extra Sharp 6-pole Crystal Roofing Filters

The Premium HF / 50 MHz Transceiver FT DX 5000

The Newly designed 9 MHz 1st IF of the FT DX 5000 main receiver implements sharp 6-pole* crystal roofing filters. *8-pole / 3 kHz Superior close-in dynamic range affords the serious DX'er the best performance possible.



The New Premium HF/50 MHz 200 W Transceiver



HF/50 MHz 200 W Transceiver

FTDX 5000MP *Limited* 200 W / Class-A 75 W

±0.05 ppm OXCO included
300 Hz, 600 Hz, and 3 kHz Crystal Roofing Filters included

Supplied Accessories

- FH-2 Remote Control Keypad
Message Keyer, Audio Message Memory
Command and Selection



- MH-31 B8 Hand Mic

Optional Accessories

- SM-5000 Station Monitor (Optional for FT DX 5000MP Limited)

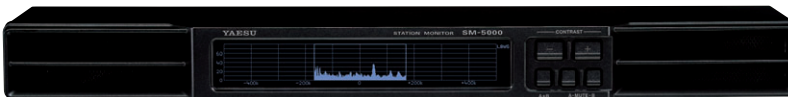

Specifications: Speakers : 65 mm (2.55 in) x 25 mm (0.98 in) x 2 sets Audio Output: 1.5 W+1.5 W (@ 8 Ω)

High-Resolution Spectrum Scope with LBWS

You can monitor activity on the VFO-A band. The RF Band Scope function allows you to view activity within a span of 25 kHz, 50 kHz, 100 kHz, 250 kHz, 500 kHz, 1 MHz, or 2.5 MHz. Choose CTR (center) or FIX modes, to limit lower and upper frequencies, and control signal levels with ATT (attenuator) 0, -10, or -20 dB. Additionally, LBWS (Limited Band Width Sweep) function allows you to reduce the bandwidth in order to increase the sweep speed.



- M-1 Reference Microphone
 - Revolutionary dual microphone configuration
 - Nine-band graphic equalizer
 - Treble Boost Cwling produces a unique tonal texture

The Answer ...

Equipped with Extra Sharp Crystal Roofing Filters

© Newly designed sharp Crystal Roofing Filters

Newly designed sharp 6-pole Crystal Roofing Filters produce excellent shape factor for the VFO - A / Main Receiver. They are selectable between 300 Hz, 600 Hz, 3 kHz, 6 kHz, and 15 kHz, and are optimized by mode for best performance. You are prepared to enjoy serious DX operation on today's crowded bands with the incomparable crisp and sharp 300Hz narrow filter!

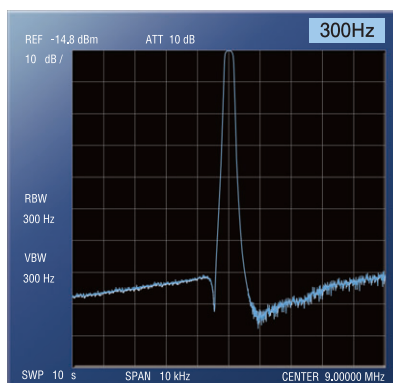

■ Characteristics and frequency response of Roofing Filter (300Hz)

© Enjoy the superb and astonishing IDR 112dB, IP3 +40dBm

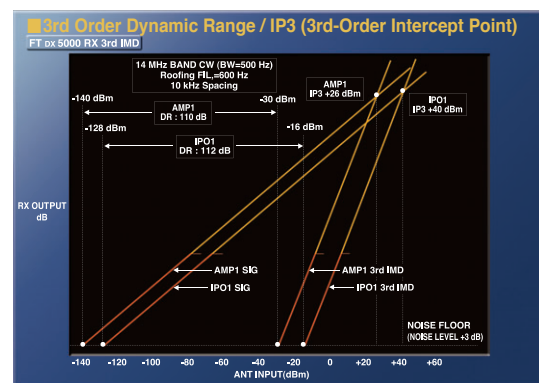

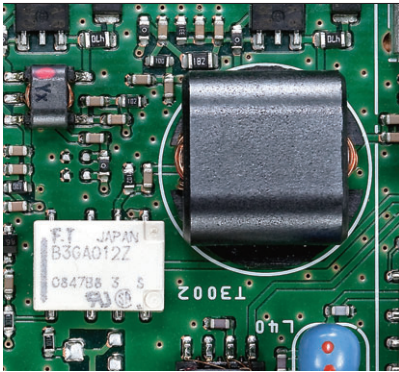

The completely new "4 selectable IPO positions" for various antennas and band conditions!

The 2SC4536 (NE46134) in the series RF amplifier design, produce a low distortion and low noise figure RF amplifier, which allows the receiver to perform at its best under the most diverse operating conditions. The new IPO System allows selection of four RF gain set-up conditions from the front panel. Choose IPO1 to feed a signal level to the mixer for the best possible IP performance. Choose IPO2 for no RF amplification.

The Double Quad Double Balanced Mixer system - Obtaining the best performance for your ultimate DX operation

Eight, 3SK294 Dual Gate MOS FETs are employed for the 1st mixer in a 2 x 4 configuration to establish the Double Quad Double Balanced Mixer. The Double Balanced Mixers using FETs have low losses by themselves so there is no need to obtain more gain than is required at the RF amp, resulting in the best desirable design for the RF Front End.

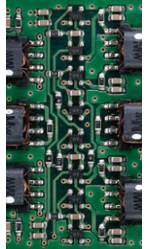

■ Mixer

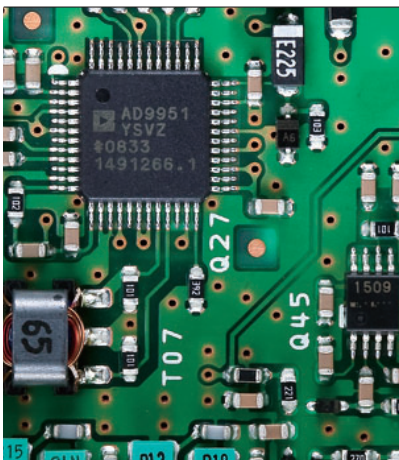

The uncompromised 400 MHz HRDDS system for the high quality local oscillator

In seeking to improve the strong-signal-handling capabilities of the receiver section, ultra-low-noise local oscillator system that produces a very clean 1st IF signal is essential. The high C/N ratio of the 400 MHz HRDDS (High Resolution Direct Digital Synthesizer) system that was implemented in the FT DX 9000 Series, has also been employed in the FT DX 5000 Series.

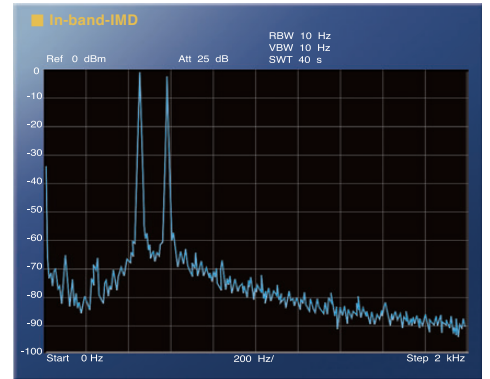

■ In-band-IMD
RX=14.200MHz CW-USB IPO1 9MFIL=300Hz
DSPFIL=300Hz AGC=SLOW PITCH=500Hz

New-design Broad-range OCXO Reference Oscillator

The 10 MHz OCXO (Oven Controlled Crystal Oscillator), with industry leading frequency stability rated at ± 0.05 ppm over the temperature range of $+14^{\circ}\text{F}$ to $+140^{\circ}\text{F}$ (-10°C to $+60^{\circ}\text{C}$), Serves as the master reference oscillator for the FT DX 5000MP.

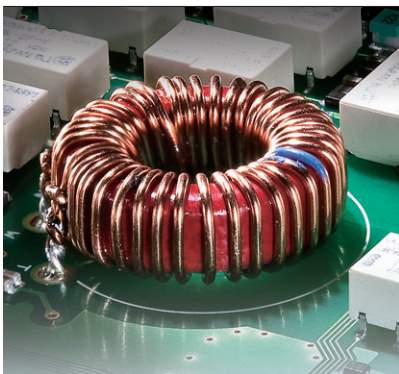

Variable RF Filter (VRF) - Covering the 1.8 - 28 MHz

To provide protection for the RF stages, as well as the two IF stages, the front end filtering system utilizes a combination of 15 fixed bandpass filters and Yaesu's exclusive VRF Preselector system. Those two RF filter systems protect the early stages of the receiver from overload caused by strong out-of-band signals. The high-Q VRF system is much narrower in bandwidth than the fixed bandpass filters, and it is crafted using high-permeability toroidal coils and tuning capacitors, producing 62 tuning steps for optimal rejection of broadcast or commercial service interference.

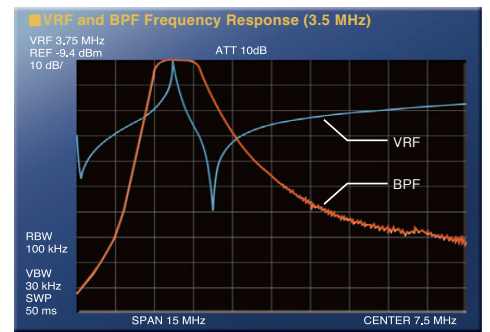

■ 10 dB/Div · 2 MHz/Div · SPAN 15 MHz (Blue VRF / Orange BPF)



The 32-bit Floating Point IF Digital Signal Processing System

■ World-renowned Variable IF WIDTH / IF SHIFT Interference Reduction Systems

The IF Shift system allows the actual passband to be moved higher or lower in frequency, eliminating interference that is encountered outside the passband, while leaving the pitch of the incoming signal and the bandwidth of the IF passband unchanged. You can also improve reception by choosing to narrow the bandwidth of the IF WIDTH function and then varying the passband with the IF SHIFT.

■ Passband Response CONTOUR Control with an Analog Touch

The incredibly sharp "brick wall" filters of the IF DSP system can expose characteristics of incoming signals that you have never heard before, and not all of them are really pleasant to listen to. Using the CONTOUR control, you can roll off low-frequency or high-frequency components to shape the receiver passband differently, or null out part of the mid-range area, with continuous adjustment throughout the passband.

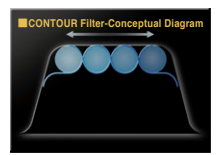

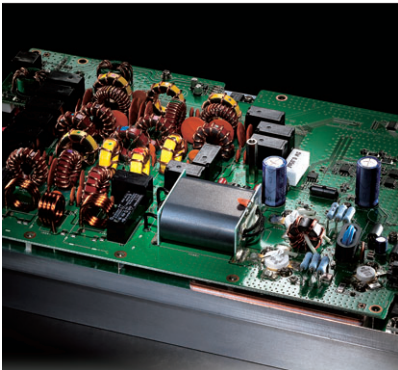

Ultra-Clean Transmitter Design

■ High-power, Super-stable Final Amplifier Stage (200 W, Class-A Mode - 75 W)

The FT DX 5000 MP utilize push-pull VRF150 MOS FET devices (VDSS=170 V, VGS=± 40 V, PD=300 W), operating at 50 V, with user-adjustable bias control to ensure the optimum suppression of intermodulation distortion products.

■ Ultimate Low Distortion Class-A Final Amplifier

The FT DX 5000 includes provision for operation in a "Class-A" mode at 75 Watts output, utilizing high bias current to produce very low transmitter intermodulation products; the 5th and higher order IMD is typically suppressed 65 dB or better!

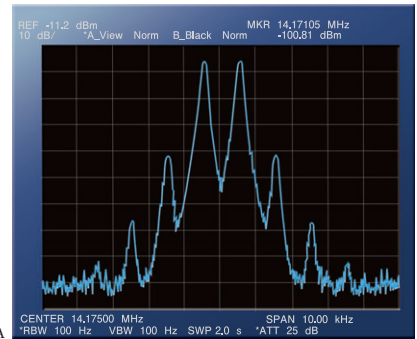

■ Class-A

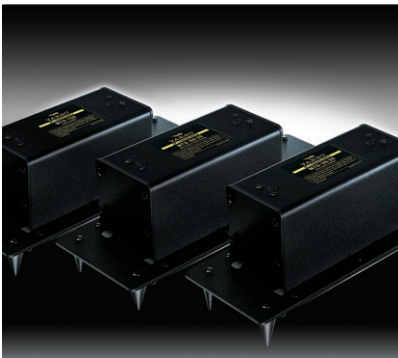

Optional Fully-automatic External μ -tuning with 1.1" (28 mm) Coil

On the lower Amateur Radio Bands, high signal voltages impinging on a receiver can create noise and intermodulation effects that may cover up weak signals you are trying to pull through. Now, three optional tuning modules (MTU-160, MTU-80/40, and MTU- 30/20) are available to cover all the Amateur Radio bands from 160-meters to the 20-meter band!

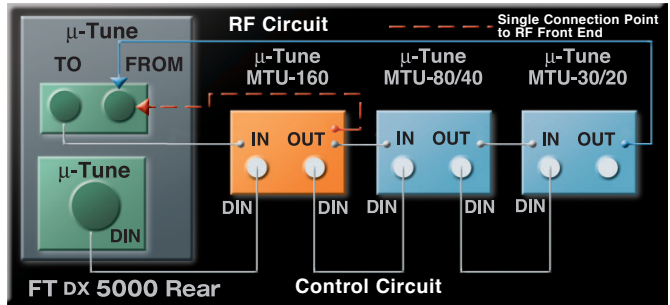

■ RF μ -Tune unit Connection Diagram

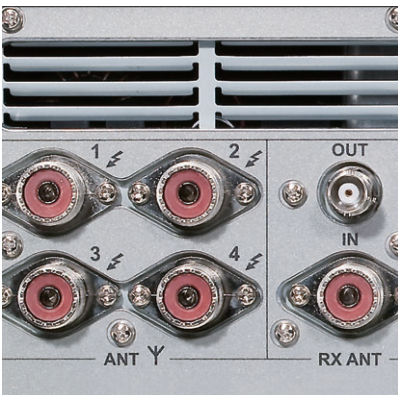

Contest-Ready Antenna Selection Capabilities

With complicated and fast-moving contest operation in mind, four TX/RX antenna sockets, and one RX only jack are provided on the rear panel. A custom external band pass filter or preamplifier may be connected between the RX ANT OUT and RX ANT input sockets. The antenna selection is memorized in each VFO and memory channel register so that you do not need to switch antennas when changing VFO's. The radio remembers which antenna you last used on that band or memory frequency channel.

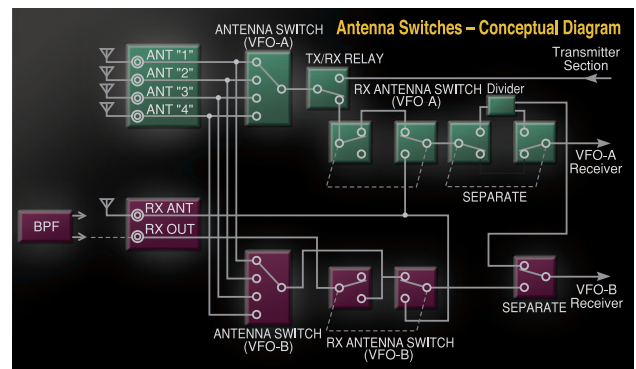

QUADRA SYSTEM



- VL-1000 HF-50 MHz 1 kW Linear Amplifier* (50 MHz: 500 W/USA Version) Automatic Antenna Tuner Built In
- VP-1000 VL-1000 Power Supply*



- SP-2000 External Speaker with Audio filters

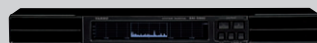

- SM-5000 Station Monitor with stereo speaker system

RF μ -Tune Kits
Wt. abt. 5.7 Lbs(2.6 kg) / 5 W x 4.7 H x 13 D in (127 x 120 x 328mm)



- RF μ -Tune Kits A For 160 m Band
- RF μ -Tune Kits B For 80/40 m Band
- RF μ -Tune Kits C For 30/20 m Band

● Up to three μ -Tune Kits may be installed. All or any μ -Tune Kits shall be installed by the users.



- SCU-17 USB Interface Unit (Requires SCU-21)

- SCU-21 Connection Cable



- M-1 Reference Microphone



- M-100 Dual-Element Microphone



- MD-200A8X Ultra High fidelity Desktop Microphone



- MD-100A8X Desktop Microphone



- YH-77STA Lightweight Stereo Headphone

- SCU-27 Antenna Rotator Connection Cable

* USA and Asian versions only

Heritage continues FT DX 3000

The FT DX 3000D is the newest member of the YAESU FT DX Series. It inherits the design concepts of the FT DX 9000 and FT DX 5000 transceivers that have received high praise from all over the world by those pursuing the highest ideal of Amateur HF communication equipment.



Building on the YAESU FT DX Heritage



HF/50 MHz 100 W Transceiver

FTDX 3000D 100 W

- ± 0.5 ppm TCXO included
- 300 Hz Crystal Roofing Filter optional
- 600 Hz Crystal Roofing Filter included
- 3 kHz Crystal Roofing Filter included

Supplied Accessories

- FH-2 Remote Control Keypad
Message Keyer, Audio Message Memory Command and Selection
- MH-31B8 Hand Mic
- T9025225 DC Cable

Optional Accessories

- M-1 Reference Microphone
 - Revolutionary dual microphone configuration
 - Nine-band graphic equalizer
 - Treble Boost Cowling produces a unique tonal texture
- SP-20 External Speaker
 - Audio Output: 7 watts
 - Impedance: 8 ohms
 - Size: W5.12" x H4.53" x D12.28" (130 x 115 x 312mm)

The RF front end boasts the ultimate receiving performance
This is the Heritage of the High Performance Receiver

◎ The powerful narrow bandwidth crystal roofing filter enhances the receiver multi-signal characteristics

The Down Conversion receiver construction is similar to the FT DX 5000. The first IF frequency is 9 MHz. This makes possible the narrow bandwidth crystal roofing filters (300 Hz, 600 Hz or 3 kHz) with a sharp shape factor, and creates the amazing multi-signal receiving performance. The 3 kHz roofing

filter greatly improves SSB signal reception, during close adjacent multi signal conditions. The 300 Hz and 600 Hz roofing filters provide the best CW receiving environment when the adjacent signals may affect the desired signal reception. *Note: 300 Hz filter optional.

◎ Phenomenal multi-signal characteristics that were demonstrated in the FT DX 5000

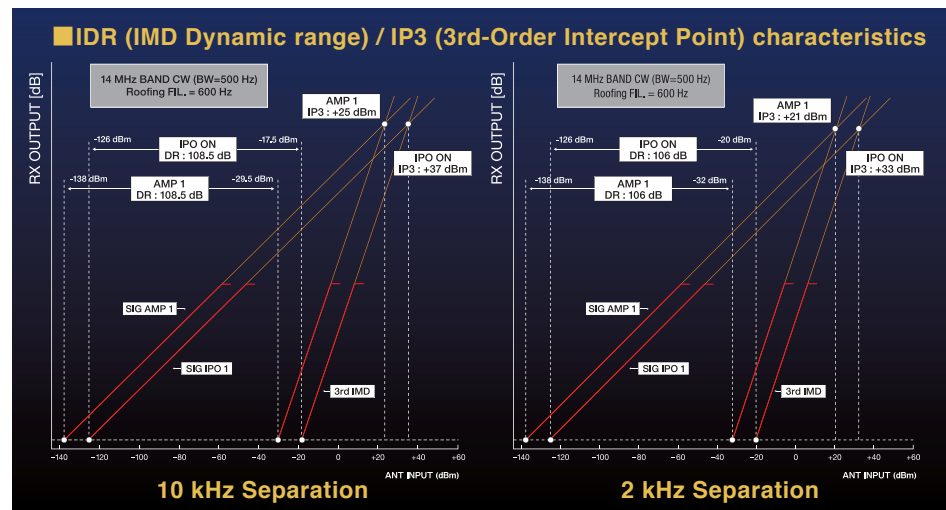

Using the two signal dynamic range measuring method with 10 kHz signal separation, the FT DX 3000 performance is 108.5 dB, IP3 +37 dBm. With frequency separation of only 2 kHz between the desired signal and an interfering signal, the dynamic range measures 106 dB and IP3 +33 dBm. This is amazing!



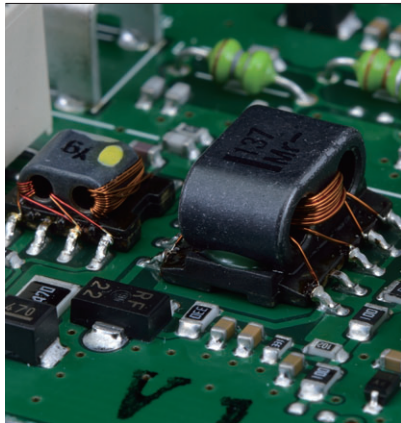

This is the tradition of the YAESU FTDX series. The RF front end realizes the ultimate receiver performance for HF radios.

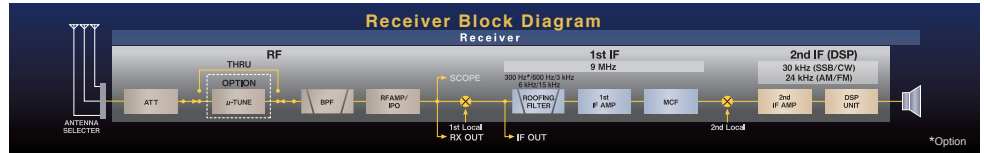

The RF front end circuit is the most important element, and determines the HF receiver performance. Our Yaesu Engineering team has concentrated superior RF engineering knowledge into the design of the FT DX 3000 front end. Fifteen separate band pass filters (BPF) are used for the front end protection, this effectively reduces the undesired and out of band signals. In the RF

amplifier, the strong bipolar transistor (2SC3357) is used. This transistor shows a low NF, and realizes superior intermodulation performance. The gain of each individual working device is kept lower, and the best optimized working point, with the lowest NF, is selected. In addition, a custom-designed wide band transformer, with less magnetic saturation, is used for the I/O of the RF amplifier.

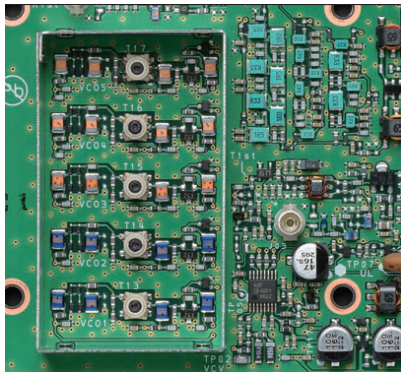

High Quality, High Stability Local Oscillator

High accuracy TCXO and the DDS & PLL circuits realize unmatched Local Oscillator signal quality

The S/N ratio (signal-to-noise ratio) of the local signal that is injected into the 1st IF mixer, is one of the most important factors for improving the receiver properties in the crowded multi-signal environment. In the FT DX 3000, the combination of the highly stable and highly accurate 40 MHz TCXO ($\pm 0.5\text{ppm}$, $-10^\circ\text{C} \sim +60^\circ\text{C}$), and the DDS, create the fundamental frequency of this radio, and is locked to the PLL-IC and VCO directly. This circuit construction and method

creates the highest quality local signal, with superior S/N performance. This means the receiver noise floor is kept lower, and realizes the best blocking dynamic range at 2 kHz IP3 performance. This is a phenomenal improvement!

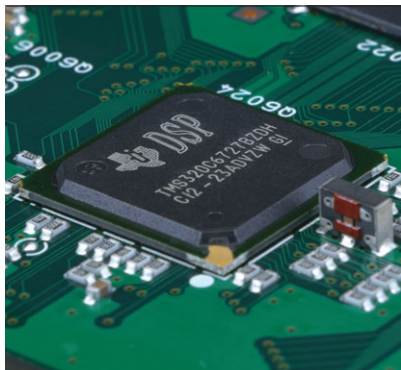
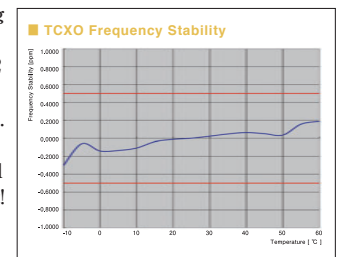

Effective QRM rejection with the FT DX 3000 IF DSP

The 32-bit high speed floating decimal point DSP, TMS320C6727B (maximum 2800 MIPS/2100 MFLOPS) made by Texas Instruments, is

used for the IF section of the FT DX 3000. The signal is processed with the high speed 300 MHz clock frequency.

Well proven IF WIDTH and IF SHIFT functions provide great QRM rejection performance

You can adjust the IF WIDTH and IF SHIFT, and eliminate the QRM, by rotating the SHIFT/WIDTH knob located on the front panel.

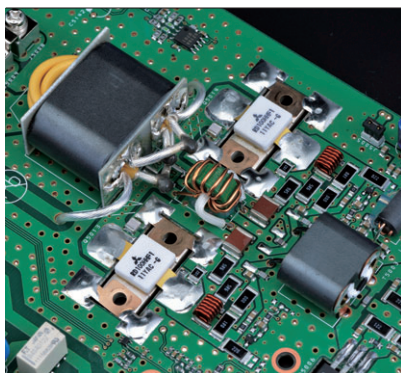
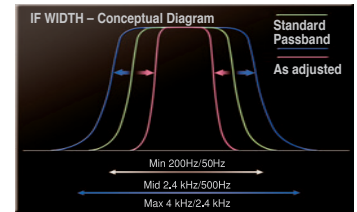
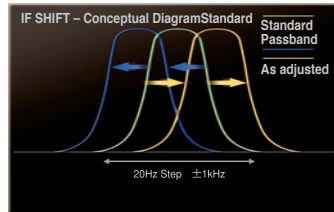

Stabilized High RF Output and High Quality Transmission Signal

The Final Amplifier provides stabilized high RF output

For the RF final amplifier, RD100HHF1 MOS FETs are used in the push-pull amplifier construction. This circuitry provides stabilized RF power performance. The amplifier produces a clean transmit signal with less spurious emissions and distortion. The large heat sink is combined with the die cast chassis and has 1200 cc capacity.

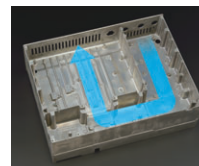

High Speed Automatic Antenna Tuner includes 100 Memory Channels

The FT DX 3000 antenna tuner is the digital type that uses LC switching. It has a large capacity memory, and the tuning data is automatically memorized in the 100 channel memory. The optimized antenna tuning data is immediately recalled to reduce tuning time when changing frequency, and the best matching point is realized.

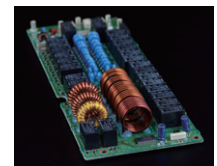

Superior Operability and Visibility

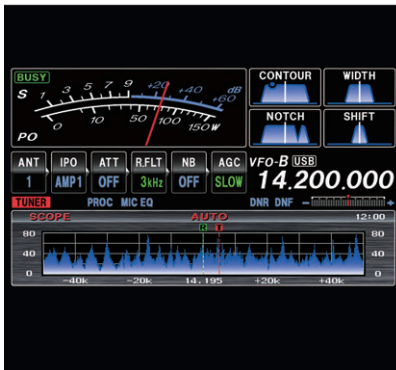

■ A huge TFT full-color display

The FT DX 3000 presents a wide, 4.3-in TFT full color display, which provides a convenient view of the radio's working functions. Even though the FT DX 3000 has many features and functions, the TFT display makes operation of the radio easy and comfortable for both new and experienced users.

■ The Block Diagram displays the RX Signal Path

The TFT color display also provides a block diagram of the radio circuitry showing the RX signal path and the RX settings. The receiver configuration and signal path can be observed

with a brief glance at the screen.

■ Separate Independent Frequency Display

The operating frequency is additionally shown in a large wide display, directly above the main VFO dial knob, and is separate from the main information display of the radio. This is one of the most important features of the FT DX 3000 transceiver. Superior operability is realized with this convenient display. A wide view angle, high contrast LCD (negative type VA-LCD), is used for the display. It permits excellent visibility from wide viewpoints.

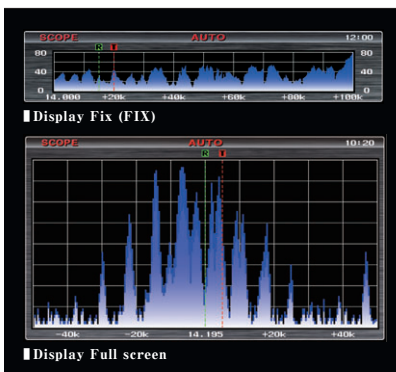

High Speed Spectrum Scope function included

The FT DX 3000 has a high speed, high resolution Spectrum Scope included as standard, making it possible to visualize signals, and tune to their frequency in the band. Changes of the signals that vary moment by moment across the band can be viewed immediately. The Bandwidth of the spectrum scope may be set to any of six different spans: 20kHz, 50kHz, 100kHz, 200kHz, 500kHz, or 1MHz. In the case of split operation, TX and RX markers will appear in the spectrum scope, making the relationship between transmit frequency and receive frequency easily observed.

AF-FFT Scope Function demonstrates the AF characteristics of the TX/RX signal

The FT DX 3000 also has an AF-FFT (Audio Frequency Fast Fourier Transform) scope built in. With this Scope, the audio characteristics of the received signals; the effect of adjusting the RX IF filter performance; and the affects of utilizing the QRM rejection features, may be visually observed.

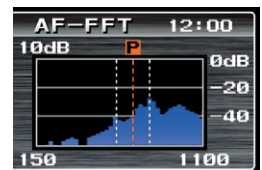

■ AF-FFT scope (normal display)



CW decode feature

The FT DX 3000 has a Morse code, decode function that can decipher and show the characters on the TFT screen. This function helps the CW beginner and supports the actual CW communications by showing the decoded message on the display.

RTTY/PSK31 Encode Decode function

The FT DX 3000 has a practical RTTY and PSK31 encoder and decoder. On the AF-FFT screen, the programmed mark and space frequencies are displayed, making it possible to easily tune to the peak of the received signal.

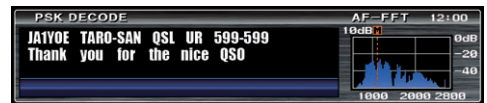
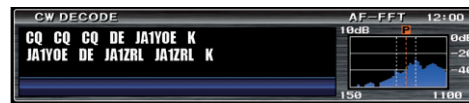

QUADRA SYSTEM



- VL-1000 HF-50 MHz 1 kW Linear Amplifier* (50 MHz: 500 W/USA Version) Automatic Antenna Tuner Built In
- VP-1000 VL-1000 Power Supply*



- XF-127CN CW Narrow Crystal Filter (C/F: 9 MHz : B/W 300 HZ)



- DVS-6 Voice Memory Unit



- FC-40 Automatic Antenna Tuner (for Long wire antenna)

- CT-178 VL-1000 Connection Cable* | ●CT-39A Packet Interface Cable
- SCU-27 Antenna Rotator Connection Cable

RF μ-Tune Kits

Wt. abt. 5.7 Lbs (2.6 kg) / 5 W x 4.7 H x 13 D in (127 x 120 x 328mm)

- RF μ-Tune Kits A For 160 m Band
- RF μ-Tune Kits B For 80/40 m Band
- RF μ-Tune Kits C For 30/20 m Band



- FP-1030 A External Power Supply* (13.8 VDC 25 A)



- FP-1023A (USA Only) External Power Supply (13.8 VDC 23 A)



- SP-20 External Speaker

● Up to three/3 μ-Tune Kits may be installed. All and any μ-Tune Kits shall be installed by the users.



- M-1 Reference Microphone



- M-100 Dual-Element Microphone



- MD-200A8X Ultra High fidelity Desktop Microphone



- MD-100A8X Desktop Microphone



- YH-77STA Lightweight Stereo Headphone

* USA and Asian versions only

High Reliability and Durability are Assured for Long-lasting Enjoyable Operations on the HF Bands **FT-891**

HF/50MHz 100W All Mode Exciting Field Gear Transceiver
 In keeping with Yaesu's uncompromising receiver design,
 The 3kHz Roofing Filter is included as standard equipment



HF/50 MHz 100 W All Mode Mobile Transceiver

FT-891

Supplied Accessories: MH-31A8J Hand Microphone, Mobile Mounting Bracket, DC Cable

Rugged construction in an Ultra Compact body

ULTRA COMPACT Design

Measuring 6.1" x 2.0" x 8.6" (155 x 52 x 218 mm), the FT-891 is an innovative Multi-band, Multi-mode Mobile/Portable transceiver with Ultra Compact and rugged case design.

100 Watts Reliable High Power Output

The FT-891 provides stable 100W high power output. High reliability is assured by the careful transmitter circuit design with efficient thermostatically-controlled Dual internal fans and the diecast chassis.



Thermostatically-controlled Dual Internal fans

Yaesu Uncompromising Receiver Circuit Design Ensures Excellent Performance

- Triple conversion with 1st IF frequency of 69.450 MHz (SSB/CW/AM)
- 3 kHz roofing filter equipped as standard
- TCXO provides ± 0.5 ppm High frequency stability (-10°C to +50°C)

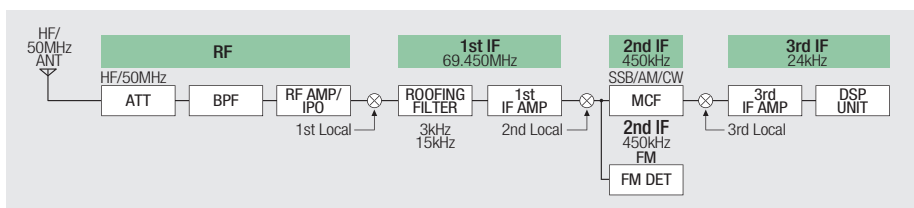

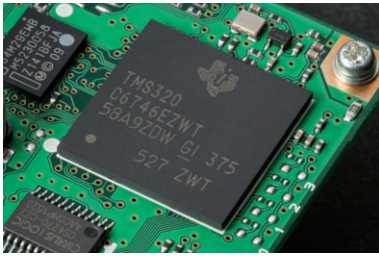

32-bit High Speed Floating Point DSP

IF DSP Provides Effective and Optimized QRM Rejection

The 32-bit high speed floating Point DSP (max 3000 MIPS) provides effective cancellation/reduction (DNR) of the random noise that is frequently frustrating in the HF frequencies. Also: the AUTO NOTCH (DNF) automatically eliminates the dominant beat tone. The CONTOUR and the APF are very effective receiver noise reduction tools in the HF bands operations. The YAESU original DSP QRM and noise reduction functions are provided.

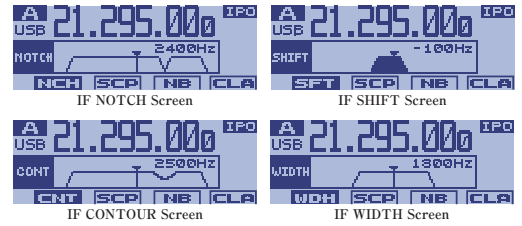

The Large Diameter Main Tuning Dial

Large Diameter Main Tuning Dial (1.6"/41mm) with Torque Adjustment

The FT-891 operation is enhanced by the large diameter (1.6"/41mm) Main Tuning Dial, which is similar in size to the tuning knob of the larger-sized HF base station. The Torque of the Main Tuning Dial can be adjusted easily for your operating preferences.

Front Panel Design Achieves Optimal Operability

- Three Programmable Front Panel Function Keys may be set to the user's personal preferences
- Multi-Function knob allows quickly changing the operating band, and adjusting other settings.
- Large Transmit/Receive indicator LEDs clearly inform the operator about the current state of the transceiver



Detachable Front Panel for Convenient Mounting and Operation

Convenient mobile operation by remotely mounting the Control Panel with the optional front panel separation kit (YSK-891)



QMB (Quick Memory Bank) Function

The QMB key accesses the five "Quick Memory Bank" registers, to organize and store groups of frequencies, and easily recall them.

Useful and Convenient Functions

- Large dot matrix LCD display with Quick Spectrum Scope
- USB port allows connection to a PC with a single cable (CAT control, PTT/RTTY control)
- TUN/LIN connector allows connection of optional FC-50 or VL-1000
- Advanced electronic keying (4 to 60 WPM) with FULL BK-IN support
- Supports Active-Tuning Antenna system (ATAS-120A, ATAS-25 :Option)



Automatic-Matching 100 Memory Antenna Tuner (Optional)

The FC-50 is an optional microprocessor-controlled antenna tuner that is designed specifically for use with the FT-891. The FC-50 can be easily attached to the FT-891.

OPTIONS

QUADRA SYSTEM

<p>● VL-1000 HF-50 MHz 1 kW Linear Amplifier*1 #2 #3 (60 MHz; 500 W; USA Version) Automatic Antenna Tuner Built In</p>	<p>● VP-1000 Power Supply*1 #2 #3</p>	<p>● MH-31 A8J Hand Microphone</p>	<p>● MH-36 E8J DTMF Hand Microphone</p>	<p>● M-1 Reference Microphone</p>	<p>● M-100 Dual-Element Microphone</p>	<p>● MD-200 A8X Ultra High fidelity Desktop Microphone</p>	<p>● MD-100 A8X Desktop Microphone</p>
<p>● YH-77STA Lightweight Stereo Headphone</p>	<p>● FC-40 Automatic Antenna Tuner*3 (for Long wire antenna)</p>	<p>● YSK-891 Front Panel Separation Kit</p>	<p>● FH-2 Remote Control Keypad*2</p>	<p>● ATBK-100 Antenna Base Kit*3 (for Base operation on 6 m Band)</p>	<p>● CT-39A Packet Interface Cable</p>	<p>● ATAS-120A Active-Tuning Antenna*3 (Automatic Type)</p>	<p>● ATAS-25 Active-Tuning Antenna (Manual Type)</p>
		<p>● FC-50 Automatic Antenna Tuner</p>			<p>● CT-58 Band Data Cable for VL-1000*1 #2 #3</p>		

*1 USA and Asian versions only *2 VL-1000 and FH-2 cannot be used simultaneously. *3 VL-1000, FC-40, and ATAS-120A cannot be used simultaneously.

Compact HF/50 MHz ALL Mode Transceiver with IF DSP FT-450D

Proven performance and technology with YAESU state-of-the-art IF DSP

The ultimate compact HF/50 MHz transceiver
YAESU FT-450D



HF/50 MHz 100 W Transceiver
FT-450D

Supplied Accessories: MH-31A8J Hand Microphone, T9023725*/T9025225(CE) DC Cable

HF/50 MHz 100 W All Mode Transceiver FT-450D with Built-in Automatic Antenna Tuner

© The Real DX Receiver! The 67.899 MHz 4 pole roofing filter (MCF) and 8 band-pass filters at the RF stages, provide excellent suppression of out-of-band interference.

The interference-filtering begins in the "RF" stages, with a double conversion superheterodyne system. The 8 band-pass filters at the RF input help eliminate out-of-band interference, followed by the RF AMP (2SK520 x 2) that feed into the active DBM (1st local) assure excellent dynamic

range. At the 1st IF stage, a powerful 4 pole roofing filter with a 10 kHz bandwidth and excellent shape factor, substantially reduces adjacent signal interference.

© Operate anywhere using optional internal or external antenna tuning systems!

The FT-450D's Automatic Antenna Tuner includes 100 memories for quick tuning during field operation when using a folded dipole, etc. In addition, the YAESU original and unique Antenna Tuning systems, such as the External Automatic Antenna Tuner FC-40 or Active Tuning Antenna System ATAS-120A for mobiles, are ready to be automatically operated with the FT-450D front panel controls.

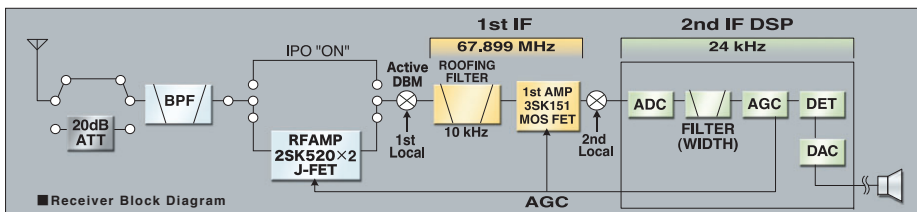

Receiver Block Diagram

World-Class Performance in an easy-to-operate HF/50 MHz transceiver package with Yaesu's unique IF DSP.

The legendary YAESU IF DSP system, well regarded among top and world-class DX operators, is now available in an easy to operate package. The new IF DSP system uses an ADSP-BF 531SBST IC, with high speed 16/32-bit, fixed point architecture. Designed and programmed with the unique objective of "Enhanced Transmit Signal Quality" and "Advanced Receiving Interference Suppression".

MANUAL NOTCH



Highly effective system that can remove an interfering beat tone or signal.

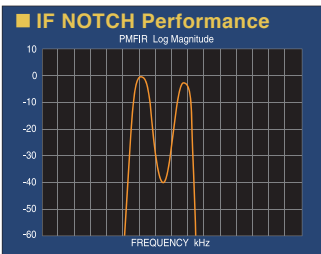

IF SHIFT



Vary the IF SHIFT higher or lower for effective interference elimination.

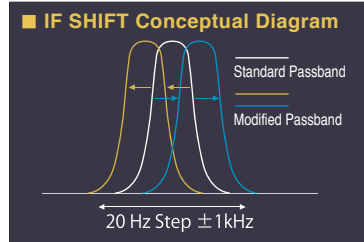

CONTOUR Control Operation



The Yaesu unique CONTOUR filter provides a gentle shaping of the passband. Specific frequency components may be suppressed or enhanced, to improve the sound and readability of the received signal with the DSP system.

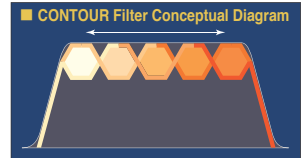

Digital Noise Reduction (DNR)



The DNR system analyzes the profile of the noise found on the HF and 50 MHz bands. Random noise is reduced and the sound and readability of the object signal is enhanced.

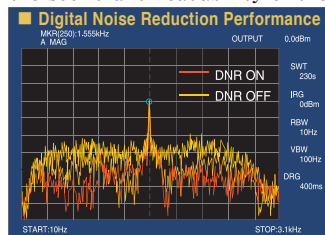

IF WIDTH



DSP IF WIDTH Tuning provides selectable IF passband widths to fight QRM. (SSB-1.8/2.4/3.0 KHz) (CW-300 Hz/500 Hz/2.4 KHz)

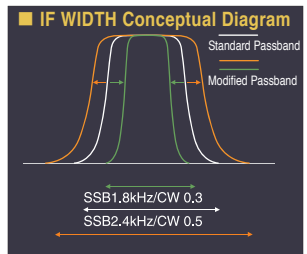

The Rugged aluminum die-cast chassis with large cooling fan is made for your heavy-duty, extended high power operation.

The newly designed push-pull power MOSFET (RDF 100HHF1) amplifiers guarantee powerful and reliable 100 W output operation. The FT-450D's rugged 490 cc aluminum die-cast chassis, with a large 2.8" x 2.8" (70 x 70mm) quiet thermostatically controlled cooling fan, is a solid foundation of the power amplifier during long hours of field use or home contesting operation.

Large informative Front Panel Display with convenient Control knobs and Switches

Even though it is a convenient compact size (9"x3.3"x8.5"/229 x 84 x 217mm), the FT-450D has a large and bright display, almost 25 % of the front panel. The original LCD negative type display shows the Frequency, S-meter, a Graphical indication of RF to IF settings, and the DSP Interference Elimination settings (Contour, Notch, DNR, Width and Shift).

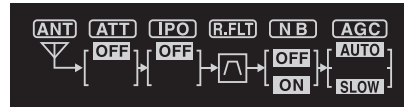

QUADRA SYSTEM

OPTIONS

- VL-1000 HF-50 MHz 1 kW Linear Amplifier* (50 MHz: 500 W/USA Version) Automatic Antenna Tuner Built In
- VP-1000 Power Supply*
- CT-118 VL-1000 Connection Cable*
- MH-36E8J DTMF Hand Microphone
- MH-31A8J Hand Microphone
- M-1 Reference Microphone
- M-100 Dual-Element Microphone
- MD-200A8X Ultra High fidelity Desktop Microphone
- MD-100A8X Desktop Microphone
- SCU-17 USB Interface Unit
- FP-1030A External Power Supply* (13.8 VDC 25 A)
- FP-1023A (USA Only) External Power Supply (13.8 VDC 23 A)
- FC-40 Automatic Antenna Tuner (for Long wire antenna)
- MHG-1 Side Carry Handle
- MMB-90 Mobile Bracket
- YH-77STA Lightweight Stereo Headphone
- CT-39A Packet Interface Cable
- ATBK-100 Antenna Base Kit (for Base operation on 6 m Band)
- ATAS-120A Active Tuning Antenna System

* USA and Asian versions only

Wide-Coverage Transceiver with Real-Time Spectrum Scope and Multi-Color Waterfall

FT-991A

A Superb All-Around Amateur Radio Transceiver with a built-in real-time spectrum scope and superior basic operating performance covering the HF/50/144/430 MHz bands



HF/50/144/430 MHz 100 W All Mode Transceiver

FT-991A (144 MHz 50 W/430 MHz 50 W)

Supplied Accessories: MH-31A8J Hand Microphone, T9025225 DC Cable

※Microphone M-1 / External Speaker SP-10 : Optional Accessories

Optional Accessories

- SP-10 External Speaker
 - Audio Output: 3 watts
 - Impedance: 8 ohms
 - Size (WHD): 4.33"x3.15"x9.96" (110x80x253mm)



Supports Real-Time Spectrum Scope with Multi-Color Waterfall Display

◎ Instantly evaluate band conditions with the built-in real-time spectrum scope

Listen to the received audio while tuning with the built-in high resolution real-time spectrum scope. Instantly evaluate ever-changing band conditions and easily find the desired signals. TX and RX markers are displayed on the scope for immediate grasp of the relationship between the TX and RX frequencies. The display color of the scope screen can be selected as preferred.

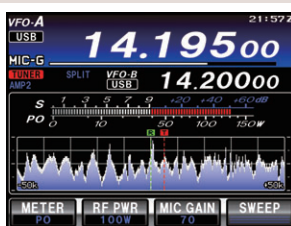

◎ Supports multi-color waterfall display

The waterfall display function presents the strength of the RX signals using color variations flowing with time. This allows for visual recognition of even the faint signals which rarely appear as peaks, offering a more detailed view of the band. The color of the waterfall screen can be selected from seven colors, or the multicolor array.

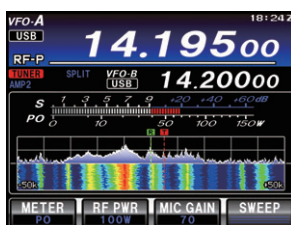

◎ Latest Touch Panel Operation, combined with traditional Front panel layout, achieves optimal operating convenience

- Full color TFT LCD display provides useful information about function status and settings at a glance
- Highly responsive panel, with functional design and intuitive layout, makes touch operation a pleasure
- Four user-customizable function keys offer quick access to mode-dependent assignments
- Traditional layout of the Main Dial knob and related controls makes experienced users feel right at home



Uncompromising Receiver Circuit Design Ensures Excellent Basic Performance from HF to VHF/UHF

◎ Sophisticated receiver front end performance on a par with FTDX Series Transceivers

■ **Triple conversion with a 1st IF frequency of 69.450MHz for all bands**

■ **1st IF stage implements a narrow bandwidth 3 kHz roofing filter as standard equipment**

Designed for outstanding adjacent multi signal characteristics, in the HF, VHF and UHF bands.



■ 3 kHz and 15 kHz Roofing Filters

■ **The 1st IF mixer for HF/50 MHz features a quad mixer that assures extremely low noise, excellent intermodulation characteristics, and high dynamic range.**

■ **A dedicated VHF/UHF mixer, is separate from the HF bands, and permits design optimization for targeted frequencies.**

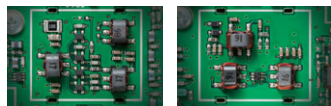

■ HF/50MHz Quad Mixer ■ VHF/UHF Mixer

◎ RF amplifier design is optimized for each band

■ **Selectable IPO/AMP1/AMP2 settings for HF and 50MHz, optimize the receiver RF amplification**

■ **Separate RF amplifiers provide the best characteristics for each band and signal conditions**

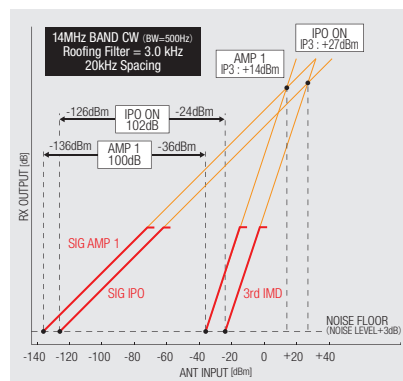

■ IDR (IMD Dynamic range) / IP3 (3rd-Order Intercept Point) characteristics

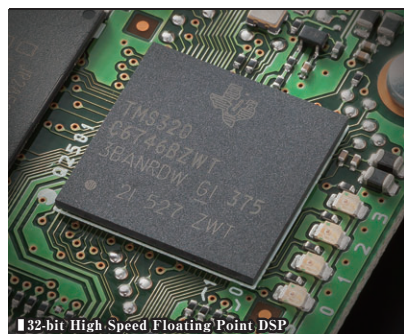

■ 32-bit High Speed Floating Point DSP

IF DSP from YAESU is Famous for Superb Interference Rejection

■ **Same high-speed floating point DSP as used in FTDX Series**

The high speed floating point DSP chip TMS320C6746 (3000 MIPS /2250 MFLOPS) makes possible excellent interference rejection with actual signals under real-world conditions.

■ **Highly effective interference rejection**

The IF WIDTH and IF SHIFT functions form the basis to effectively remove interfering signals. The DNF (AUTO NOTCH) filter rapidly tracks and removes even multiple heterodyne signals.

The CONTOUR function can emphasize the desired audio components for the most distinguishable communications sound. The selectable bandwidth NOTCH is combined with the other noise reducing functions to provide convenient DX and Contest QSO operation.

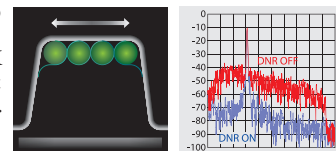

■ CONTOUR Filter Conceptual Diagram ■ Digital Noise Reduction Performance

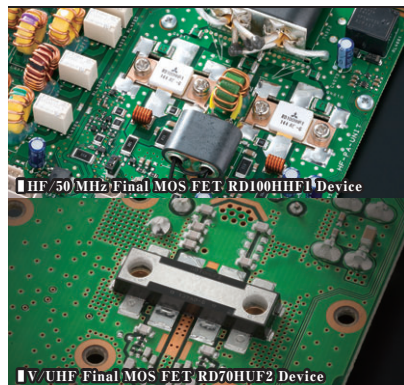

■ HF/50MHz Final MOS FET RD100HHF1 Device

■ V/UHF Final MOS FET RD70HUF2 Device

Final Stages Provide Ample Power Reserves: 100 W for HF/50 MHz Band and 50 W for VHF/UHF Band

■ **High quality push-pull amplifier with 100 watts for HF and 50 MHz**

Using a push-pull arrangement of RD100HHF1 MOS-FET devices that are renowned for excellent performance in the HF and 50 MHz frequencies.

■ **High speed 1.8 to 54 MHz antenna tuner included as standard equipment**

■ **50 W amplifier for VHF/UHF assures plenty of power for high frequency bands**

The final amplifier for the VHF and UHF bands uses the high-output MOS-FET RD70HUF2 device, providing ample output power of 50 watts.

Support for Advanced C4FM Digital Functions

- V/D mode for simultaneous transmission of voice and data with powerful error correction is optimal for mobile use, and for Voice FR (Full Rate) mode high quality audio transmission
- AMS function instantly recognizes digital mode or FM mode, and enables automatic communication with stations using either mode.
- GM (Group Monitor) function allows handy on-screen display of group members that are within communication range
- 126 types of DSQ (Digital Squelch) enable specific selection of communicating stations
- Supports high-definition Amateur Radio WIRES-X internet connection, utilizing C4FM digital technology

*Does not support operation of WIRES-X digital node stations.
*Does not support sending and receiving of images via C4FM digital.

QUADRA SYSTEM

● VL-1000
HF-50 MHz 1 kW Linear Amplifier*1 *2 *3
(50 MHz: 500 W/USA Version)
Automatic Antenna Tuner Built In

● VP-1000
Power Supply*1 *2 *3

● CT-58
Band Data Cable for VL-1000*1 *2 *3

● FH-2
Remote Control Keypad*2

● FP-1023A (USA Only)
External Power Supply (13.8 VDC 23 A)

● FP-1030A
External Power Supply*1
(13.8 VDC 25 A)

● FC-40
Automatic Antenna Tuner*3
(for Long wire antenna)

● M-1 Reference Microphone	● M-100 Dual-Element Microphone	● MD-200A8X Ultra High fidelity Desktop Microphone	● MD-100 A8X Desktop Microphone
● MH-36E8J DTMF Hand Microphone	● MH-31 A8J Hand Microphone	● ATBK-100 Antenna Base Kit*3 (for Base operation on 6 m Band)	● ATAS-25 Active-Tuning Antenna (Manual Type)
● SP-10 External Speaker	● YH-77STA Lightweight Stereo Headphone	● CT-39A Packet Interface Cable	● ATAS-120A Active-Tuning Antenna*3 (Automatic Type)
		● MMB-90 Mobile Bracket	

*1 USA and Asian versions only *2 VL-1000 and FH-2 cannot be used simultaneously. *3 VL-1000, FC-40, and ATAS-120A cannot be used simultaneously.

Wide-Coverage HF-UHF CW/SSB/AM/FM

Ultra-Compact HF/VHF/UHF 100W All Mode Transceiver FT-857D

The world's smallest HF/VHF/UHF Mobile transceiver, provides base station performance from an ultra-compact package



HF/50/144/430 MHz 100 W All Mode Transceiver

FT-857D (144 MHz 50 W/430 MHz 20 W)

Supplied Accessories: MH-31A8J Hand Microphone, MMB-82 Mobile Mounting Bracket, T9023225 DC Cable, YSK-857 Separation Kit

The FT-857D is the choice of experts for high-performance mobile operation!



Large Main Tuning Dial and Outstanding Ergonomics

The FT-857D Ease of operation is enhanced by the large diameter 1.7" (Ø43 mm) Main Tuning Dial (10 Hz steps minimum), similar in size to the tuning knob of many base station rigs.

SELECT Knob and Quick Access Key

The SELECT knob permits "channelized" tuning in minimum steps of 1kHz on SSB/CW, or 5kHz on FM, for quick and easy tuning across the band. The most important keys are strategically placed about the front panel, for quick access.

High-Performance Receiver Design

Yaesu engineers have crafted the FT-857D frontend for a very low noise floor, along with a wide dynamic range. Extensive band-pass filtering in the front end, along with careful device selection and gain distribution, yield a receiver system that is ready for the strong-signal challenges of today's crowded bands!

Wide Frequency Coverage

Transmitter coverage of the HF, 50MHz, 144MHz, and 430MHz Amateur bands. The FT-857D also includes receive coverage on 100kHz to 56MHz, 76 to 108MHz, 118-164MHz, and 420-470MHz.

Upgrade with Collins® Mechanical Filters for SSB and CW (optional)

To enhance performance on both receive and transmit, high-performance Collins® Mechanical Filter options are available

- 2.3kHz, 10-pole YF-122S
- 500Hz, 7-pole YF-122C
- 300Hz, 7-pole YF-122CN



Rugged, High-Output Transmitter Design

The FT-857D utilizes rugged MOSFET Transistor devices in the power amplifier section, providing low noise, low distortion, and high reliability. Dependability is assured thanks to the extensive cooling system, featuring a thermostatically-controlled fan and aluminum die-cast chassis.

Useful and Convenient Functions

- Active Tuning Antenna System (ATAS-120A : Option)
- CW Operating Flexibility (Built-in Electric Keyer; CW Message Memory with Beacon Mode; CW Pitch; Side tone Control)
- Built-in Enhanced DSP Transceiver Performance.

OPTIONS

<p>● MH-59A8J Remote Control DTMF Microphone</p>	<p>The optional MH-59A8J Remote Microphone provides control of the major functions of the FT-857D from the microphone keypad. The MH-59A8J includes a rotary control knob for adjusting the operating frequency and the receiver volume level</p>	<p>● MH-36E8J DTMF Microphone</p>	<p>● MH-31A8J Hand Microphone</p>	<p>● M-1 Reference Microphone</p>	<p>● M-100 Dual-Element Microphone</p>	<p>● MD-200A8X Ultra High fidelity Desktop Microphone</p>	<p>● MD-100A8X Desktop Microphone</p>	<p>● YH-77STA Lightweight Stereo Headphone</p>
<p>● SSB YF-122S(2.3 kHz) Collins® Mechanical Filters</p>	<p>● CW YF-122C (500 Hz) CW YF-122CN (300 Hz) Collins® Mechanical Filters</p>	<p>● TCXO-9 0.5 ppm High-Stability Reference Oscillator</p>	<p>● CT-58 Band Data Cable for VL-1000*</p>	<p>● CT-39A Packet Interface Cable</p>	<p>● CT-62 CAT Computer Interface Cable</p>	<p>● SCU-17 USB Interface Unit (Requires CT-62)</p>		
<p>● VL-1000 HF-50 MHz 1 kW Linear Amplifier* (50 MHz: 500 W/USA Version) Automatic Antenna Tuner Built In</p>	<p>● VP-1000 VL-1000 Power Supply*</p>	<p>● YSK-857 Separation Kit</p>	<p>● FC-30 Bolt-on Automatic Antenna Tuner</p>	<p>● FC-40 Automatic Antenna Tuner (for Long wire antenna)</p>	<p>● ATAS-25 Active-Tuning Antenna (Manual Type)</p>	<p>● ATAS-120A Active-Tuning Antenna (Automatic Type)</p>		

*USA and Asian versions only

The Ultimate Compact FT-818ND Transceiver Wide-Band Coverage & Portability

Enjoy Outdoor Portable Operation with Full Features



HF/50/144/430MHz 6W All Mode Portable Transceiver

FT-818ND

Supplied Accessories: SBR-32 Ni-MH Battery Pack (9.6 V, 1900mAh), PA-48 Battery Charger, MH-31A8J Hand Microphone, FBA-28 Battery Case (holds 8 "AA" Alkaline cells [not included]), YHA-63 Whip Antenna for (50/144/430 MHz), DC Cable, Shoulder Strap

Best Performance for Outdoor Amateur Radio Operation

Ultimate Compact Transceiver with 6 Watts TX Power Output

Measures 5.31" (W) x 1.5" (H) x 6.5" (D) (135 x 38 x 165mm) and Light weight (under 2 pounds / 900g), the FT-818ND is an innovative, Multi-mode, wide-band, portable transceiver, within an ultra-compact body, providing up to 6W of stable and reliable output power. TX power level can be selected from four levels, 6W/5W/2.5W/1W. Outdoor operation can be enjoyed with the same convenience as a handheld transceiver. *6W(SSB/CW/FM), 2W(AM); 13.8VDC input *C4FM Digital mode is not supported

High Stability TCXO Built-In

Built-in TCXO provides ± 0.5 ppm high frequency stability (-10°C to +60°C) and maintains stable high-quality communication for SSB operation in the VHF/UHF band, and CW operation within a narrow band.

Ready to Operate from Various Sources of Power

Simple and convenient outdoor operation in any environment, the FT-818ND is ready to operate from multiple power sources:

- Supplied 1900mAh high-capacity Ni-MH battery pack (and battery charger)
- Supplied Alkaline Battery case, (8 alkaline "AA" cells not included).
- External 13.8VDC power source (External DC cable supplied)



* Depending on the version

Full featured CW Operation from a Portable

- CW "Semi Break-in": Receiver recovery Time (10ms to 2500ms in 10ms step)
- CW Reverse: Provides BFO injection LSB, instead of the default USB side.
- CW Pitch Control: CW side tone pitch adjustment (300Hz to 1000Hz in 50Hz steps)
- Built-in Electronic Keyer with speed adjustment (4WPM to 60WPM / 20CPM to 300CPM)

High Performance Collins® Mechanical Filters for SSB and CW (Optional)

To enhance performance on receiver, Collins® Mechanical Filter options are available.

Multi-Function Keys for Easy Feature Access

The "SELECT" knob, together with the "[A] [B] [C]" keys, provides ease of operation and quick efficient access to the many high-performance features.



Select Knob Multi-Function Keys

Two Antenna Connectors for Ease of Installation and Operation

The FT-818ND has two antenna terminals, a BNC and an M type. The desired antenna connection for each band may be selected in Menu Mode.



Front Panel (BNC) Rear panel (Type M)

Multi-Functional Display for Easy Operation

A wealth of information is available on the Multi-color display.



Spectrum Scope Monitor

Double Size Frequency Display

Valuable Features

- 208 Memory Channels
- Versatile Scan Features
- Equipped with dedicated Data Connector
- CAT System control interface

DESKTOP MICROPHONE

Find New Pleasure in Creating Your Own Unique Vocal sound
Engineered for the Most Discriminating Ham Radio Operators

REFERENCE MICROPHONE

M-1

〈Supplied Accessories〉
AC adapter /
Microphone cable /
Treble Boost Cowling



Microphone with
Treble Boost Cowling

DUAL-ELEMENT MICROPHONE

M-100

〈Supplied Accessories〉
Microphone cable /
Treble Boost Cowling



Microphone with
Treble Boost Cowling

© Reference Microphone M-1

- Revolutionary dual microphone configuration features both dynamic and condenser elements
- Nine-band graphic equalizer for each microphone element
- TBC (Treble Boost Cowling) produces a unique tonal texture
- Long stroke Smooth Operating PTT key
- Solid aluminum die cast mic stand
- High visibility ON AIR LED
- Large display (featuring anti-reflective AR coating)
- Built-in record and playback feature
- Headphone output for real-time monitoring
- Built-in one-click Low-Cut filter
- Cannon-type(XLR) Output
- One-touch PTT keylock



M-1 Operating panel
(Nine-band graphic equalizer)



Dual Microphone
Configuration



Long stroke PTT key



M-100 Operating panel
(One-touch, Low-Cut and High-Cut filters)

© Dual-Element Microphone M-100

- Revolutionary dual microphone configuration features both dynamic and condenser elements
- TBC (Treble Boost Cowling) produces a unique tonal texture
- Long stroke Smooth Operating PTT key
- High visibility ON AIR LED
- Built-in one-click Low-Cut and High-Cut filters
- One-touch PTT keylock

Specifications	M-1	M-100
Microphone elements	Dynamic and condenser microphones	Dynamic and condenser microphones
Supply Voltage	DC 5 V ±5 %	DC 5 V ±10 %
Frequency Response	30 - 17000 Hz	30 - 17000 Hz
Sensitivity	-60 dB(1kHz 0 dB = 1V/1Pa)	-60 dB(1kHz 0 dB = 1V/1Pa)
Mic Impedance	600 Ohms	600 Ohms
Headphone Output Impedance	16 Ohms(TYP)	-
Headphone Output Level	15 mW(TYP)	-
RX AUDIO IN(Input Level)	100 mVrms(TYP)	-
Dimensions(WxHxD)	5.5" x 11.0" x 6.0"(140 x 280 x 152 mm) *	5.0" x 11.0" x 5.4"(126x 280 x 137 mm) *
Weight(approx)	2.11 lbs (960g) w/o Cable	2.00 lbs (910g) w/o Cable

* Dimensions (H): Maximum with microphone flat

Applicable Models (M-1 and M-100)		
FTDX101 Series	FTDX9000 Series	FTDX5000 Series
FTDX3000D	FTDX1200	FT-891
FT-450/D	FT-991/FT-991A	FT-857/D
FT-817/ND, FT-818ND	FT-2000/D	FT-950
FT-897/D	FT-920	FT-900
FT-847	FT-1000MP	FT-1000MP-MKV
FT-1000 *1	FT-990 *1	FT-850 *1
FT-840 *1	FT-747 *1	-

*1 Requires Optional "Power Supply Kit for M-100" for connecting of the M-100

ANTENNAS & TUNERS

Auto Active-Tuning Antenna

ATAS-120A



Yaesu patented ATAS™ (Active-Tuning Antenna System) provides HF/VHF/UHF coverage with automatic motorized tuning. Utilizing control signals from the transceiver microprocessor conducted via the coaxial cable, the ATAS internal motor adjusts the antenna length for best SWR. The ATAS covers the 7/14/21/28/50/144/430MHz bands.

■ Specifications

Frequency Range: 7/14/21/28/50/144/430 MHz
Amateur Bands
Height (Approx.): 4.59~5.24 ft (1.4~1.6 m)
Weight (Approx.): 1.98 lb (900 g)
Input Impedance: 50Ω
Max Input Power: 120W (SSB/CW, 50% Duty)
Matched SWR : Less than 2.0 : 1
(with proper counterpoise)



Active-Tuning Antenna

ATAS-25



The ATAS-25 is a manually-adjusted portable antenna ideal for field use with the HF Transceivers. Designed for mounting on a standard camera tripod (1/4" stud), the ATAS-25 is tuned by sliding the shorting section of the loading coil assembly up or down and selecting the appropriate number of top sections. Counterpoise wires are supplied.

■ Specifications

Frequency Range: 7/14/21/28/50/144/430 MHz
Amateur Bands
Height (Approx.): Max. 7.2 ft (2.2 m) during Operation
Min. 1.96 ft (0.6 m) for Transporting
Weight (Approx.): 2.05 lb (930 g)
Input Impedance: 50Ω
Max Input Power: HF/50MHz: 100W (SSB/CW, 50% Duty)
50W (AM/FM)
144/430 MHz: 50W (ALL MODE)
Matched SWR : Less than 2.0 : 1

■ Supplied Items

Radiating Elements
Radial Element (for VHF band)
Radial Element (for UHF band)
Radial Wires (20 ft (6 m),
9.8 ft (3 m) & 6.6 ft (2 m) Length)
Spare Radial Wire (32.8 ft (10 m) Length)
Allen Wrench



© Innovative FC-30 (optional)
Automatic Antenna Tuner

The FC-30 is a high-speed, relay-controlled Automatic Antenna Tuner utilizing a combination of sixteen capacitors and nine low-loss coils to reduce SWR as presented to the FT-857D feedpoint.

Automatic Antenna Tuner

FC-30

■ Specifications

Frequency Range : 1.8 ~ 30 MHz, 50 ~ 54 MHz
 Input Impedance : 50 Ω
 Maximum Power : 100 Watts
 Matched SWR : 1.5 : 1 or less
 Tune-up Power : 4 W ~ 60 W
 Tune-up Time : 5 seconds or less
 Impedance Matching Range : 1.8 ~ 30 MHz, 50 ~ 54 MHz: 16.5 Ω ~ 150 Ω
 Impedance Matching Memories : 100 channels
 Input Voltage Requirement : 13.8 V ± 15% (supplied from transceiver)
 Operating Temperature Range : 14° F ~ 122° F (-10°C ~ + 50°C)
 Case Size (WHD) : 3.1" x 1.8" x 10.2" (80 x 45 x 260 mm)
 Weight : 2.2 lb (1 kg)



© Automatic-Matching 200-Memory Antenna Tuner FC-40 (optional)

The FC-40 is a microprocessor-controlled antenna impedance matching network designed to provide all-amateur-band transmitting capability with the transceivers, when used with an end-fed random wire or long whip antenna.

Automatic-Matching 200-Memory Antenna Tuner

FC-40

■ Specifications

Frequency Range : 1.8 - 54 MHz with 20+ m end-fed wire, 7 - 54 MHz with YA-007 HF 2.5 m Mobile Whip Antenna
 Input Impedance : 50 Ω
 Max Power : 100 Watts (3 minutes Maximum Continuous TX)
 Matched SWR : 2.0:1 or less (if antenna is not a multiple of λ/2)
 Tune-up Power : 4 W ~ 60 W
 Tune-up Time : 8 seconds maximum
 Impedance Matching Memories : 200 channels
 Power Supply : 13.8 V ± 15% (supplied from transceiver)
 Case Size (WHD) : 9" x 7" x 2.1" (228 x 175 x 55 mm)
 Weight : 2.6 lb (1.2 kg)



© Automatic-Matching 100-Memory Antenna Tuner (optional)

The FC-50 is a microprocessor-controlled antenna tuner that is designed specifically for the FT-891. The FC-50 can be easily attached to the FT-891.

Automatic-Matching 100-Memory Antenna Tuner

FC-50

■ Specifications

Frequency Range : 1.8 - 29.7MHz, 50 - 54MHz
 Input Impedance : 50 Ω
 Maximum Power : 100 Watts
 Matched SWR : 1.5 : 1 or less
 Tune-up Power : 4W - 60W
 Tune-up Time : 5 seconds or less
 Impedance Matching Range : 1.8 - 29.7MHz = 16Ω - 150Ω
 50 - 54MHz = 25Ω - 100Ω
 Impedance Matching Memories : 100 channels
 Input Voltage Requirement : 13.8V ± 15% (supplied from transceiver)
 Case Size (WHD) : 6.1" x 1.8" x 8.3" (155 x 45 x 210.5 mm)
 Weight : 3lb (1.35kg)



ROTATORS

G-2800DXA/DXC

Extra Heavy Duty
 Supplied Accessories:
 40 m Control cable with Connector*1



G-1000DXA/DXC

Medium / Heavy Duty



G-800DXA
G-800SA

Medium Duty



G-450A/C

Light Duty



G-5500

Azimuth-Elevation Rotator

Models	G-2800DXA*2 G-2800DXC*2	G-1000DXA*2 G-1000DXC*2	G-800DXA*2	G-800SA	G-450A G-450C	G-5500
Recommended Application	Heavy-duty applications. Recommended for in-tower mounting.	Medium/heavy-duty for large HF arrays.	Medium-duty, for medium/large HF/VHF arrays.		Light to medium duty. Low price, perfect entry level rotator.	Azimuth-Elevation Combination for space communication.
Wind Load	3 m ²	2.2 m ²	2 m ²	2 m ²	1 m ²	1 m ²
K-Factor*3	950	230	180	180	100	60
Stationary Torque	25,000 kg/cm	6,000 kg/cm	4,000 kg/cm	4,000 kg/cm	3,000 kg/cm	AZ: 4,000 kg/cm EL: 4,000 kg/cm
Rotation Torque	2,500~800 kg/cm	1,100~600 kg/cm	1,100~600 kg/cm	800 kg/cm	600 kg/cm	AZ: 600 kg/cm EL: 1,200 kg/cm
Max. Vert. Load	300 kg	200 kg	200 kg	200 kg	100 kg	30 kg
Max. Vert. Intermittent Load	1,200 kg	800 kg	800 kg	800 kg	300 kg	100 kg
Backlash	0.2°	1°	1°	1°	0.5°	AZ: 1° EL: 1°
Mast Size	48-63 φ	38-63 φ	38-63 φ	38-63 φ	32-63 φ	AZ: 38-62 φ EL: 38-62 φ
360° Rotation Time	50~120 sec	40~100 sec	40~100 sec	55 sec	63 sec/50 Hz 51 sec/60 Hz	AZ: 70 sec/50 Hz 58 sec/60 Hz
180° Elevation Time	N/A	N/A	N/A	N/A	N/A	EL: 80 sec/50 Hz 67 sec/60 Hz
Boom Diameter	N/A	N/A	N/A	N/A	N/A	EL 32~43 φ
Direct control from YAESU HF radio*4	○	○	○	N/A	N/A	N/A
PC control*5	○	○	○	N/A	N/A	○
Rotator Diameter x Height	200 φ x 345	186 φ x 300	186 φ x 300	186 φ x 300	186 φ x 263	186 φ x 254 (W) x 350 (H)
Rotator Weight	6.5 kg	3.6 kg	3.6 kg	3.6 kg	3.5 kg	7.8 kg
Cable Requirement	6	6	6	5	5	2 x 6
Supply AC Voltage	DXA: 117/220 V DXC: 220 V (CE)	DXA: 117/220 V DXC: 220 V (CE)	117/220 V	117/220 V	A: 117/220 V C: 220 V (CE)	117/220 V

*1: USA version only

*2: On models with "DXA/DXC" suffix, rotation speed and torque will vary with the speed control setting.

*3: K-Factor: Multiply turning radius times weight; add K-Factor for each antenna in "Christmas Tree" installations.

*4: Depending on HF radios, please refer to catalog of YAESU HF radio.

*5: Requires optional GS-232B.

Rotator Unit Dimensions

G-2800DXA/DXC

G-1000DXA/DXC
G-800DXA
G-800SA

Rotator Attachment Dimensions

Tower-Mounted Antennas

Pole-Mounted Antennas

OPTIONS

● GS-232B
Computer Controller for all DXA/DXC Series and G-5500 Rotators

● GS-680U
Universal Bearing

● GS-065
Thrust Bearing

● GS-050
Thrust Bearing

● GA-3000
Absorber Joint for G-2800DXA/DXC Rotators

● GC-038B/G
Mast Clamp (Brown/Green) for G-1000DXA/DXC, G-800DXA, G-800SA, and G-450A/C Rotators

● GC-048
Mast Clamp for G-2800DXA/DXC Rotators

● GL-33
Mast Adjustment Plate

● GA-2500
Absorber Joint for G-1000DXA/DXC, G-800DXA, G-800SA, and G-450A/C Rotators

● Control Cables

- 40 m Control cable with Connector
- 25 m Control cable with Connector

The New Standard of Excellence in Linear Amplifier Technology!

QUADRA SYSTEM

For a bold, clean signal from "Top Band" through the "Magic Band",
the VL-1000/VP-1000 QUADRA SYSTEM belongs in your station!



HF / 50 MHz 1 kW Linear Amplifier*1 *2

VL-1000

48V 48A Switching Power Supply*1

VP-1000

Innovative Quadra Push-Pull RF Design for 1 kW of MOSFET Power

Yaesu's engineers have conquered the challenging task of providing high power output from 160 through 6 meters! Yaesu's exclusive Quadra Push-Pull amplifier design utilizes 8 rugged MRF-150 MOS FETs for years of reliable operation. Special attention to system grounding and RF bypassing ensures very low spurious emissions, even at maximum power output.

High-Performance Switching Relays with Automatic Maintenance Mode

Active Safety Protection Circuitry Assures Reliability and Quick Diagnosis of System Anomalies

Powerful 16-bit Control CPU Provides High-Speed Antenna Tuning with Extensive Memory and Multi-Band Memory Date Backup

The heart of the control circuitry of the VL-1000 is a 16-bit microprocessor, driven by a

Yaesu exclusive tuning algorithm in software. The on-board return-loss bridge analyzes the antenna system performance, instantly sending tuning instructions to the stepper motors in the antenna tuner section.

Large Dot-Matrix LCD Display Features World's First Panoramic SWR Monitor

The huge 7.6" x 1.7" (190 x 43 mm) dot-matrix LCD provides a wealth of amplifier-status information, including peak power output, average power output, voltage, current, and SWR data. Another Yaesu "World First" feature is the Panoramic SWR Monitor, which displays "before tuning" and "after tuning" SWR information for points across a band, providing you with instant data regarding antenna system performance.

Automatic Band Change for Quick QSY

When operating with most modern Yaesu transceivers, band data information can be transferred between transceiver and amplifier, allowing automatic amplifier band change

when you change bands on the latest Yaesu's HF / 50 MHz transceivers. The VL-1000 also provides Automatic Band Change via frequency-sensing circuit which instantly changes band when RF drive is first applied, for use with other excitors.

Direct Air Flow Cooling System Provides Efficient Dissipation of Heat

Twin high-speed fans, thermostatically controlled, quietly direct cooling air across the 76 vanes of the heat sink, efficiently transferring heat out of the amplifier compartment. Both the VL-1000 Amplifier and VP-1000 Power Supply have their own fan systems with independent thermostats.



Two Input and Four Output Antenna Jacks for Versatile Integration Opportunities Your Station

VL-1000 Specifications

General

Frequency Range: 1.8 - 54 MHz Amateur bands only

Power Output: (220V AC Input)
1000W (SSB/CW)
500W (FSK-RTTY/FM)
250W (AM Carrier)
(120V AC Input)
500W (SSB/CW/FSK-RTTY/FM)
125W (AM Carrier)

Input Voltages: DC+48V, DC+12V, DC-12V

Current Consumption: 48A(DC+48V), 2.8A(DC+12V), 0.1A(DC-12V)

Dimensions: 16.5" x 6.0" x 18.0"

(including feet and switches) 413 W x 151 H x 451D mm

Weight: 46.3 lb (21 kg)

Linear Amplifier Section

Input Power: 2,100 W max
RF Drive Power: 80 W(max) for full output
Spurious Emissions: Better than -50 dB (HF)
Better than -70 dB (50 MHz band)
3rd-order intermodulation Products: At least -30 dB
Input impedance: 50 Ohms, unbalanced
Output impedance: 50 Ohms, unbalanced

Automatic Antenna Tuner

Matching Range: 16.7 Ω - 100 Ω (1.8 MHz band)
25 Ω - 100 Ω (50 MHz band)
16.7 Ω - 150 Ω (all other bands)

Maximum power: 1200 Watts
Insertion Loss: 0.5 dB
Matched SWR: Less than 1.5 : 1

VP-1000 Power Supply

Input Voltage: AC 100 - 240 V (Automatic switching)
Output Voltage: DC + 48 V, DC+12 V, DC-12 V
AC Current Drain: 13 A (AC 200 - 240 V @ 1kW output)
15 A (AC 100 - 200 V @ 500W output)

Dimensions: 16.5" x 6.0" x 15.2"

413 W x 151 H x 381D mm



(including feet and switches)

Weight: 32.3 lb (14.6 kg)

Options



CT - 58 Band Data Cable (For FT-991A, FT-891, FT-857D)
CT - 118 Connection Cable (For FT - 450D, FTDX1200)
CT - 178 Connection Cable (For FTDX101, FTDX3000)

*1 USA and Asian versions only *2 USA version is shipped from factory with 24 / 28 MHz Amateur bands operation disabled.



Series	HF-50MHz																																						
	FTDX 101 Series		FTDX 5000																																				
																																							
Model number	FTDX 101MP	FTDX 101D	FTDX 5000MP Limited																																				
RX Frequency Range	30 kHz - 75 MHz (operating) 1.8 MHz - 54 MHz (Specified performance, Amateur bands only) 70 MHz - 70.5 MHz (Specified performance, UK Amateur bands only)	30 kHz - 75 MHz (operating) 1.8 MHz - 54 MHz (Specified performance, Amateur bands only) 70 MHz - 70.5 MHz (Specified performance, UK Amateur bands only)	30 kHz - 60 MHz (operating)* 1.8 - 54 MHz (specified performance, Amateur bands only)*																																				
TX Frequency Ranges	1.8 MHz - 54 MHz (Amateur bands only) 70 MHz - 70.5 MHz (UK Amateur bands only)	1.8 MHz - 54 MHz (Amateur bands only) 70 MHz - 70.5 MHz (UK Amateur bands only)	1.8 - 54 MHz (Amateur bands only)																																				
Emission Modes	A1A (CW), A3E (AM), J3E (LSB,USB), F3E (FM), F1B (RTTY), G1B (PSK)	A1A (CW), A3E (AM), J3E (LSB,USB), F3E (FM), F1B (RTTY), G1B (PSK)	A1A (CW), A3E (AM), J3E (LSB/USB), F3E (FM), F1B (RTTY), F1D (PACKET), F2D (PACKET)																																				
Frequency Steps	1/5/10 Hz (SSB, CW), 10/100 Hz (AM, FM)	1/5/10 Hz (SSB, CW), 10/100 Hz (AM, FM)	1 Hz, 5 Hz, 10 Hz (CW, SSB, AM), 100Hz (FM)																																				
Antenna Impedance	50 ohms, unbalanced (Antenna Tuner OFF) 16.7-150 Ohms, unbalanced (Tuner ON, 1.8-29.7 MHz Amateur bands) 25-100 Ohms, unbalanced (Tuner ON, 50 MHz Amateur band)	50 ohms, unbalanced (Antenna Tuner OFF) 16.7-150 Ohms, unbalanced (Tuner ON, 1.8-29.7 MHz Amateur bands) 25-100 Ohms, unbalanced (Tuner ON, 50 MHz Amateur band)	50 Ohms, unbalanced 16.7 - 150 Ohms, unbalanced (Tuner ON, 1.8 - 29.7 MHz Amateur bands) 25 - 100 Ohms, unbalanced (Tuner ON, 50 MHz Amateur band)																																				
Operating Temperature Range	+32 °F - +122 °F (0 °C - +50 °C)	+32 °F - +122 °F (0 °C - +50 °C)	+14 °F - +140 °F (-10 °C - +60 °C)																																				
Frequency Stability	±0.1 ppm (+14 °F to +140 °F / -10 °C to +60 °C after 1 minutes)	±0.1 ppm (+14 °F to +140 °F / -10 °C to +60 °C after 1 minutes)	±0.05 ppm (+14 °F - +140 °F / -10 °C - +60 °C, after 5 min)																																				
Supply Voltage	100 VAC/ 200 VAC	DC13.8V ± 10%	90 VAC~264 VAC																																				
Power Consumption (Approx.) (@ 117 VAC) (@ 13.8VDC: FTDX101D)	RX (no signal) 100 VA RX (signal present) 120 VA TX (200 W) 720 VA	RX (no signal) 3.5 A RX (signal present) 4.0 A TX (100 W) 23 A	RX (no signal) 70 VA RX (signal present) 80 VA TX (200 W) 720 VA																																				
Dimensions (WxHxD)	16.6" x 5.1" x 12.7" (420 x 130 x 322 mm) w/o Knob	16.6" x 5.1" x 12.7" (420 x 130 x 322 mm) w/o Knob	18.2" x 5.3" x 15.3" (462 x 135 x 389 mm) w/o knob and connector																																				
Weight (Approx.)	29.8 lbs (13.5 kg)	26.5 lbs (12 kg)	46.3 lbs (21 kg)																																				
Power Output	5W - 200W (CW, SSB, FM, RTTY, PKT) 5W - 50W (AM)	5W - 100W (CW, SSB, FM, RTTY, PKT) 5W - 25W (AM)	10W - 200W (CW, SSB, FM, RTTY, PKT) Class-A (SSB) 10W - 75W 5W - 50W (AM)																																				
Modulation Types	J3E (SSB) : Balanced A3E (AM) : Low-Level (Early Stage) F3E (FM) : Variable Reactance	J3E (SSB) : Balanced A3E (AM) : Low-Level (Early Stage) F3E (FM) : Variable Reactance	J3E (SSB) : Balanced A3E (AM) : Low-Level (Early Stage) F3E (FM) : Variable Reactance																																				
Maximum FM Deviation	± 5.0 kHz / ± 2.5 kHz	± 5.0 kHz / ± 2.5 kHz	± 5.0 kHz / ± 2.5 kHz																																				
Harmonic Radiation	Better than -50dB (1.8 MHz - 29.7 MHz Amateur bands) Better than -66 dB (50 MHz Amateur Band)	Better than -50dB (1.8 MHz - 29.7 MHz Amateur bands) Better than -63 dB (50 MHz Amateur Band)	Better than -60 dB (1.8 - 30 MHz Amateur bands) Better than -66 dB (50 MHz Amateur band)																																				
SSB Carrier Suppression	At least 60 dB below peak output	At least 60 dB below peak output	At least 60 dB below peak output																																				
Undesired Sideband Suppression	At least 60 dB below peak output	At least 60 dB below peak output	At least 60 dB below peak output																																				
3rd-order IMD (14 MHz) ※PEP	-31 dB (200 W)	-31 dB (100 W)	-31 dB (14 MHz, 200 W) -40 dB (14 MHz, 75 W Class-A)																																				
Bandwidth	3.0 kHz (LSB, USB), 500 Hz (CW) 6.0 kHz (AM), 16 kHz (FM)	3.0 kHz (LSB, USB), 500 Hz (CW) 6.0 kHz (AM), 16 kHz (FM)	3.0 kHz (LSB, USB), 500 Hz (CW) 6.0 kHz (AM), 16 kHz (FM)																																				
Audio Response (SSB)	Not more than -6 dB from 300 to 2700 Hz	Not more than -6 dB from 300 to 2700 Hz	Not more than -6 dB from 300 to 2700 Hz																																				
Microphone Impedance	600 Ohms (200 to 10 k Ohms)	600 Ohms (200 to 10 k Ohms)	600 Ohms (200 to 10 k Ohms)																																				
Circuit Type	Double-conversion Superheterodyne	Double-conversion Superheterodyne	VFO-A : Double - conversion superheterodyne VFO-B : Triple - conversion superheterodyne																																				
Intermediate Frequencies	<table border="1"> <tr> <td></td> <td>MAIN</td> <td>SUB</td> </tr> <tr> <td>1st. Frequencies</td> <td>9.005 MHz</td> <td>8.9000 MHz</td> </tr> <tr> <td>2nd. Frequencies</td> <td>24 kHz</td> <td>24 kHz</td> </tr> <tr> <td>3rd. Frequencies</td> <td>—</td> <td>—</td> </tr> </table>		MAIN	SUB	1st. Frequencies	9.005 MHz	8.9000 MHz	2nd. Frequencies	24 kHz	24 kHz	3rd. Frequencies	—	—	<table border="1"> <tr> <td></td> <td>MAIN</td> <td>SUB</td> </tr> <tr> <td>1st. Frequencies</td> <td>9.005 MHz</td> <td>8.9000 MHz</td> </tr> <tr> <td>2nd. Frequencies</td> <td>24 kHz</td> <td>24 kHz</td> </tr> <tr> <td>3rd. Frequencies</td> <td>—</td> <td>—</td> </tr> </table>		MAIN	SUB	1st. Frequencies	9.005 MHz	8.9000 MHz	2nd. Frequencies	24 kHz	24 kHz	3rd. Frequencies	—	—	<table border="1"> <tr> <td></td> <td>VFO A</td> <td>VFO B</td> </tr> <tr> <td>1st. Frequencies</td> <td>9.000 MHz</td> <td>40.455 MHz</td> </tr> <tr> <td>2nd. Frequencies</td> <td>30 kHz (24 kHz for AM/FM)</td> <td>455 kHz</td> </tr> <tr> <td>3rd. Frequencies</td> <td>—</td> <td>30 kHz (24 kHz for AM/FM)</td> </tr> </table>		VFO A	VFO B	1st. Frequencies	9.000 MHz	40.455 MHz	2nd. Frequencies	30 kHz (24 kHz for AM/FM)	455 kHz	3rd. Frequencies	—	30 kHz (24 kHz for AM/FM)
	MAIN	SUB																																					
1st. Frequencies	9.005 MHz	8.9000 MHz																																					
2nd. Frequencies	24 kHz	24 kHz																																					
3rd. Frequencies	—	—																																					
	MAIN	SUB																																					
1st. Frequencies	9.005 MHz	8.9000 MHz																																					
2nd. Frequencies	24 kHz	24 kHz																																					
3rd. Frequencies	—	—																																					
	VFO A	VFO B																																					
1st. Frequencies	9.000 MHz	40.455 MHz																																					
2nd. Frequencies	30 kHz (24 kHz for AM/FM)	455 kHz																																					
3rd. Frequencies	—	30 kHz (24 kHz for AM/FM)																																					
Sensitivity	SSB/CW (2.4 kHz, 10 dB S+N/N) 0.16 μV (1.8 - 30 MHz, AMP2) 0.125 μV (50 MHz - 54 MHz, AMP2) 0.16 μV (70 - 70.5 MHz, AMP2) AM (6 kHz, 10 dB S+N/N, 30% modulation @400 Hz) 6.3 μV (0.5 MHz - 1.8 MHz) 2 μV (1.8 MHz - 30 MHz, AMP2) 1 μV (50 MHz - 54 MHz, AMP2) 2 μV (70 MHz - 70.5 MHz, AMP2) FM (12 kHz, 12 dB SINAD, 1 kHz, 3.5 kHz DEV) 0.25 μV (28 MHz-30 MHz, AMP2) 0.2 μV (50 MHz - 54 MHz, AMP2) 0.25 μV (70 MHz - 70.5 MHz, AMP2)	SSB/CW (2.4 kHz, 10 dB S+N/N) 0.16 μV (1.8 - 30 MHz, AMP2) 0.125 μV (50 MHz - 54 MHz, AMP2) 0.16 μV (70 - 70.5 MHz, AMP2) AM (6 kHz, 10 dB S+N/N, 30% modulation @400 Hz) 6.3 μV (0.5 MHz - 1.8 MHz) 2 μV (1.8 MHz - 30 MHz, AMP2) 1 μV (50 MHz - 54 MHz, AMP2) 2 μV (70 MHz - 70.5 MHz, AMP2) FM (12 kHz, 12 dB SINAD, 1 kHz, 3.5 kHz DEV) 0.25 μV (28 MHz - 30 MHz, AMP2) 0.2 μV (50 MHz - 54 MHz, AMP2) 0.25 μV (70 MHz - 70.5 MHz, AMP2)	SSB/CW (2.4 kHz, 10 dB S+N/N) 2 μV (0.5 - 1.8 MHz, IPO1) 0.2 μV (1.8 - 30 MHz, AMP2)* 0.125 μV (50 - 54 MHz, AMP2) AM (6 kHz, 10 dB S+N/N, 30% modulation @400 Hz) 6 μV (0.5 - 1.8 MHz, IPO1) 2 μV (1.8 - 30 MHz, AMP2)* 1 μV (50 - 54 MHz, AMP2) FM (BW : 15 kHz, 12 dB SINAD) 0.5 μV (28 - 30 MHz, AMP2) 0.35 μV (50 - 54 MHz, AMP2) There is no specification in frequency ranges not listed.																																				
Selectivity	Mode -6 dB -60 dB CW 0.5 kHz or better 0.75 kHz or less SSB 2.4 kHz or better 3.6 kHz or less AM 6 kHz or better 15 kHz or less FM 12 kHz or better 25 kHz or less	Mode -6 dB -60 dB CW 0.5 kHz or better 0.75 kHz or less SSB 2.4 kHz or better 3.6 kHz or less AM 6 kHz or better 15 kHz or less FM 12 kHz or better 25 kHz or less	Mode -6 dB -60 dB CW 0.5 kHz or better 0.75 kHz or less LSB , USB 2.4 kHz or better 3.6 kHz or less AM 6 kHz or better 15 kHz or less FM 12 kHz or better 30 kHz or less																																				
Image Rejection	70 dB or better (1.8 - 28 MHz Amateur bands) 60 dB or better (50 MHz Amateur band)	70 dB or better (1.8 - 28 MHz Amateur bands) 60 dB or better (50 MHz Amateur band)	70 dB or better (1.8 - 30 MHz Amateur bands, VRF: ON) 60 dB or better (50 MHz Amateur band)																																				
Maximum Audio Output	2.5 W into 4 Ohms with 10% THD	2.5 W into 4 Ohms with 10% THD	2.5 W into 4 Ohms with 10% THD																																				
Audio Output Impedance	4 to 16 Ohms (4 Ohms: nominal)	4 to 16 Ohms (4 Ohms: nominal)	4 to 8 Ohms (4 Ohms : nominal)																																				
Conducted Radiation	Less than 4 nW	Less than 4 nW	Less than 4 nW																																				
			* Except the 9 MHz.																																				

● Specifications are subject to change, in the interest of technical improvement, without notice or obligation, and are guaranteed only within the amateur bands.

SPECIFICATIONS

Series	HF-50MHz		
	FT DX 3000D	FT-891	FT-450D
			
Model number	FT DX 3000D	FT-891	FT-450D
RX Frequency Range	30 kHz - 56 MHz (operating) 1.8 - 54 MHz (specified performance, Amateur bands only)	30 kHz - 55.999995 MHz (Amateur bands only)	30 kHz - 56 MHz (operating) 1.8 - 54 MHz (specified performance, Amateur bands only)
TX Frequency Ranges	1.8 - 54 MHz (Amateur bands only)	1.8 - 54 MHz (Amateur bands only)	1.8 - 54 MHz (Amateur bands only)
Emission Modes	A1A (CW), A3E (AM), J3E (LSB, USB), F3E (FM), F1 B (RTTY), G1B (PSK)	A1A (CW), A3E (AM), J3E (LSB, USB), F2D, F3E (FM)	A1A (CW), A3E (AM), J3E (LSB, USB), F3E (FM)
Frequency Steps	1 Hz, 5 Hz, 10 Hz (CW, SSB, AM), 100 Hz (FM)	2/5/10 Hz (SSB, CW), 10/100 Hz (AM, FM)	1 Hz, 10 Hz, 20 Hz (CW, SSB), 100 Hz, 200 Hz (AM, FM)
Antenna Impedance	50 Ohms, unbalanced 16.7 - 150 Ohms, unbalanced (Tuner ON, 1.8 - 29.7 MHz Amateur bands) 25 - 100 Ohms, unbalanced (Tuner ON, 50 MHz Amateur band)	50 Ohms, unbalanced	50 Ohms, unbalanced 16.5 - 150 Ohms, unbalanced (Tuner ON, 1.8 - 50 MHz Amateur bands)
Operating Temperature Range	+14°F - +122°F (-10°C - +50°C)	+14°F - +122°F (-10°C - +50°C)	+14°F - +122°F (-10°C - +50°C)
Frequency Stability	±0.5 ppm (14°F - +122°F / -10°C - +50°C, after 1 min)	±0.5 ppm (@14°F - +122°F / -10°C - +50°C, after 1 min)	±1 ppm /hour (@77°F / +25°C, after warm-up)
Supply Voltage	DC 13.8 V ± 10% (Negative Ground)	DC 13.8 V ± 15% (Negative Ground)	DC 13.8 V ± 10% (Negative Ground)
Power Consumption	RX(no signal) 1.8 A RX(signal present) 2.1 A TX(100 W) 23 A	Receive: 2.0 A (signal present) Transmit: 23 A	RX(signal present) 1.5A TX(100 W) 22 A
Dimensions (WxHxD)	14.4" x 4.5" x 12.3" (365 x 115 x 312 mm)	6.1" x 2.0" x 8.6" (155 x 52 x 218 mm) w/o knobs	9" x 3.3" x 8.5" (229 x 84 x 217 mm)
Weight (Approx.)	22.0 lbs (10 kg)	4.18 lbs (1.9 kg)	8.8 lbs (4.0 kg)
Power Output	5 - 100 W (2 - 25 W AM carrier)	100 W (SSB/CW/FM) 40 W (AM)	5 - 100 W (2 - 25 W AM carrier)
Modulation Types	J3E (SSB) : Balanced A3E (AM) : Low-Level (Early Stage) F3E (FM) : Variable Reactance	J3E (SSB) : Balanced A3E (AM) : Low-Level (Early Stage) F3E (FM) : Variable Reactance	J3E (SSB) : Balanced A3E (AM) : Low-Level (Early Stage) F3E (FM) : Variable Reactance
Maximum FM Deviation	±5.0 kHz / ±2.5 kHz	±5.0 kHz / ±2.5 kHz	±5.0 kHz / ±2.5 kHz
Harmonic Radiation	Better than -60 dB (1.8 - 30 MHz Amateur bands: Harmonics) Better than -50 dB (1.8 - 30 MHz Amateur bands: Others) Better than -63 dB (50 MHz Amateur band)	Better than -50 dB (1.8 MHz - 30 MHz Amateur bands) Better than -63 dB (50 MHz Amateur bands)	Better than -60 dB (1.8 - 30 MHz Amateur bands) Better than -70 dB (50 MHz Amateur band)
SSB Carrier Suppression	At least 60 dB below peak output	At least 50 dB below peak output	At least 60 dB below peak output
Undesired Sideband Suppression	At least 60 dB below peak output	At least 50 dB below peak output	At least 60 dB below peak output
3rd-order IMD (14 MHz) ※PEP	-31dB (100W)	—	—
Bandwidth	3.0 kHz (LSB, USB), 500 Hz (CW) 6.0 kHz (AM), 16 kHz (FM)	3.0 kHz (LSB, USB), 500 Hz (CW) 6.0 kHz (AM), 16 kHz (FM)	3.0 kHz (LSB, USB), 500 Hz (CW) 6.0 kHz (AM), 16 kHz (FM)
Audio Response (SSB)	Not more than -6 dB from 300 to 2700 Hz	Not more than -6 dB from 300 to 2700 Hz	Not more than -6 dB from 300 to 2400 Hz
Microphone Impedance	600 Ohms (200 to 10 k Ohms)	600 Ohms (200 to 10 k Ohms)	600 Ohms (200 to 10 k Ohms)
Circuit Type	Double-conversion superheterodyne	Triple-conversion Superheterodyne (SSB/CW/AM) Double Conversion Superheterodyne (FM)	Double-conversion superheterodyne
Intermediate Frequencies	1st. Frequencies 9,000MHz 2nd. Frequencies 30kHz (24 kHz for AM/FM) 3rd. Frequencies —	1st. 69.450 MHz 2nd. 450 kHz 3rd. 24 kHz (SSB/CW/AM)	67.899MHz 24kHz —
Sensitivity	SSB/CW (BW: 2.4 kHz, 10 dB S+N/N) 0.16 μV (1.8 - 30 MHz, AMP2) 0.125 μV (50 - 54 MHz, AMP2) AM (BW: 6 kHz, 10 dB S+N/N, 30% modulation @400 Hz) 2 μV (0.5 - 1.8 MHz, AMP2) 2 μV (1.8 - 30 MHz, AMP2) 1 μV (50 - 54 MHz, AMP2) FM (BW: 15 kHz, 12 dB SINAD) 0.5 μV (28 - 30 MHz, AMP2) 0.35 μV (50 - 54 MHz, AMP2) There is no specification in frequency ranges not listed.	SSB/CW (S/N 10 dB) 0.16 μV (1.8 - 30 MHz) 0.16 μV (50 - 54 MHz) (S/N 10 dB) 5 μV (0.5 - 1.8 MHz) 1.6 μV (1.8 - 30 MHz) 1.6 μV (50 - 54 MHz) (12 dB SINAD) 0.35 μV (29 MHz, 50 - 54 MHz)	SSB/CW (BW: 2.4 kHz, 10 dB S+N/N) 0.25 μV (1.8 - 20 MHz) 0.25 μV (3.5 - 30 MHz) 0.20 μV (50 - 54 MHz) AM (BW: 6 kHz, 10 dB S+N/N, 30% modulation @400 Hz) 2 μV (1.8 - 2.0 MHz) 2 μV (3.5 - 30 MHz) 1 μV (50 - 54 MHz) FM (BW: 10 kHz, 12 dB SINAD) 0.50 μV (28 - 30 MHz) 0.30 μV (50 - 54 MHz) There is no specification in frequency ranges not listed.
Selectivity	Mode -6 dB -60 dB CW/RTTY/PKT 0.5 kHz or better 0.75 kHz or less SSB 2.4 kHz or better 3.6 kHz or less AM 6 kHz or better 15 kHz or less FM 12 kHz or better 25 kHz or less	Mode -6 dB -60 dB SSB/CW 2.4 kHz or better 3.6 kHz or less CW-N 500 Hz or better 750 Hz or less AM 6 kHz or better 15 kHz or less FM 12 kHz or better 30 kHz or less (-50dB) FM-N 9 kHz or better 25 kHz or less (-50dB)	Mode -6 dB -60 dB CW-N 0.25 kHz or better 0.7 kHz or less SSB 2.2 kHz or better 4.5 kHz or less AM 6 kHz or better 20 kHz or less FM 15 kHz or better 30 kHz or less FM-N 9 kHz or better 25 kHz or less
Image Rejection	70 dB or better (1.8 - 30 MHz Amateur bands) 60 dB or better (50 MHz Amateur band)	70 dB or better (HF/50 MHz Amateur bands)	80 dB or better (1.8 - 30 MHz Amateur bands) 65 dB or better (50 MHz Amateur band)
Maximum Audio Output	2.5 W into 4 Ohms with 10% THD	2.5 W into 4 Ohms with 10% THD	2.2 W into 4 Ohms with 10% THD
Audio Output Impedance	4 to 8 Ohms (4 Ohms : nominal)	4 to 16 Ohms (8 Ohms : nominal)	4 to 16 Ohms (8 Ohms : nominal)
Conducted Radiation	Less than 4 nW	Less than 4 nW	Less than 4 nW

● Specifications are subject to change, in the interest of technical improvement, without notice or obligation, and are guaranteed only within the amateur bands.

Series	HF-UHF CW/SSB/AM/FM/C4FM	HF-UHF CW/SSB/AM/FM	
	FT-991A	FT-857D	FT-818ND
			
Model number	FT-991A	FT-857D	FT-818ND
RX Frequency Range	30 kHz - 56 MHz, 118 - 164 MHz, 420 - 470 MHz (operating) 1.8 - 54 MHz, 144 - 148MHz, 430 - 450 MHz (specified performance, Amateur bands only)	100 kHz - 56 MHz, 76 - 108 MHz (WFM only), 118 - 164 MHz, 420 - 470 MHz (operating)	100kHz - 56MHz 76MHz - 154MHz, 420MHz - 470MHz
TX Frequency Ranges	1.8 - 54 MHz, 144 - 148MHz, 430 - 450 MHz (Amateur bands only)	1.8 - 54 MHz, 144 - 148 MHz, 430 - 450 MHz (Amateur bands only) 5.1675MHz Alaska Emergency Frequency (Depending on the version)	1.8 - 54 MHz, 144 - 148 MHz, 430 - 450 MHz (Amateur bands only) 5.1675MHz Alaska Emergency Frequency (Depending on the version)
Emission Modes	A1A (CW), A3E (AM), J3E (LSB, USB), F2D, F3E (FM) F7W (C4FM)	A1 (CW), A3 (AM), A3J (LSB, USB), F3 (FM) F1 (9600 bps packet), F2 (1200 bps packet)	A1A (CW), A3E (AM), J3E (LSB/USB), F3E (FM), F1D (9600 bps packet), F2D (1200 bps packet)
Frequency Steps	5 / 10 Hz (SSB, CW, AM), 100 Hz (FM, C4FM)	10Hz(CW/SSB),100Hz(AM, FM, WFM)	10Hz (CW/SSB), 100Hz (AM/FM)
Antenna Impedance	50 Ohms, unbalanced 16.7 - 150 Ohms, unbalanced (Tuner ON, 1.8 - 30 MHz Amateur bands) 25 - 100 Ohms, unbalanced (Tuner ON, 50 MHz Amateur band)	50 Ohms, unbalanced	50 ohms, Unbalanced (Front: Type BNC, Rear: Type M)
Operating Temperature Range	+14 ° F - +122 ° F (-10 ° C - +50 ° C)	+14 ° F - +140 ° F (-10 ° C - +60 ° C)	+14 ° F to +140 ° F (-10 ° C to +60 ° C)
Frequency Stability	±0.5 ppm (@14°F - +122°F/-10° C - +50° C, after 1 min)	±4 ppm from 1 min. to 60 min after power on @25 ° C: 1 ppm/hour ±0.5 ppm/1 hour @25 ° C, after warmup (with optional TCXO-9)	±0.5ppm (CW/SSB/AM), ±1 kHz ±0.5ppm (FM)
Supply Voltage	DC 13.8 V ±15 % (Negative Ground)	Nominal: 13.8 VDC ±15 %, (Negative Ground)	Nominal: 13.8VDC ± 15 %, Negative Ground Operating: 8.0 - 16.0V, Negative Ground FBA-28 (w/8 "AA" Alkaline Cells): 12.0V SBR-32MH (Ni-MH Battery Pack): 9.6V
Power Consumption	RX (no signal) : 1.8 A RX (signal present) : 2.2 A TX : 23 A (HF/50MHz 100 W), 15 A (144/430MHz 50 W)	Squelched : 600 mA (Approx.) Receive : 1 A Transmit : 22 A	Squelched: 300mA (Approx.) Receive: 450mA Transmit: 2.4A (HF/50MHz/144MHz), 2.7A (430MHz)
Dimensions (WxHxD)	9" x 3.2" x 10" (229 x 80 x 253 mm)	6.1" x 2" x 9.2" (155 x 52 x 233 mm)	5.31" x 1.5" x 6.50" (135 x 38 x 165mm)
Weight (Approx.)	9.5 lbs (4.3 kg)	4.6 lbs (2.1 kg)	1.98 lbs (900g) w/o battery, antenna, and Microphone
Power Output	SSB/CW/FM AM Carrier 1.8 - 54 MHz : 100 W 25 W 144/430 MHz : 50 W 12.5 W (Amateur bands only)	SSB/CW/FM AM Carrier 1.8 - 54 MHz : 100 W 25 W 144 MHz : 50 W 12.5 W 430 MHz : 20 W 5 W (Amateur bands only)	6 W (SSB/CW/FM), 2 W (AM Carrier) @13.8 V
Modulation Types	J3E (SSB) : Balanced A3E (AM) : Low-Level (Early Stage) F3E (FM) : Variable Reactance F7W (C4FM) : 4-level FSK	SSB : Balanced Modulator AM : Low Level (Early Stage) FM : Variable Reactance	SSB: Balanced Modulator AM : Early Stage (Low Level) FM: Variable Reactance
Maximum FM Deviation	±5.0 kHz / ±2.5 kHz	±5.0 kHz / ±2.5 kHz	±5kHz (FM-N: ±2.5kHz)
Harmonic Radiation	Better than -50 dB (1.8 - 30 MHz Amateur bands) Better than -63 dB (1.8 - 30 MHz Amateur bands, above 30MHz)* Better than -63 dB (50 MHz Amateur band) Better than -60 dB (144 MHz, 430 MHz Amateur bands)	-50 dB (1.8-29.7 MHz Amateur bands) -60 dB (50/144/430 MHz Amateur bands)	-50dB (1.8-29.7MHz Amateur bands) -60dB (50/144/430MHz Amateur bands)
SSB Carrier Suppression	At least 50 dB below peak output	At least 40 dB below peak output	At least 40dB below peak output
Undesired Sideband Suppression	At least 50 dB below peak output	At least 50 dB below peak output	At least 50dB below peak output
3rd-order IMD (14 MHz) ※PEP	—	-31 dB (100 W)	—
Bandwidth	3.0 kHz (LSB, USB), 500 Hz (CW) 6.0 kHz (AM), 16 kHz (FM, C4FM)	3.0 kHz (LSB, USB) , 500 Hz (CW) 6.0 kHz (AM), 16 kHz (FM)	3.0kHz (LSB, USB) , 500Hz (CW) 6.0kHz (AM), 16kHz (FM)
Audio Response (SSB)	Not more than -6 dB from 300 to 2700 Hz	400 Hz - 2600 Hz (-6 dB)	400Hz-2600Hz (-6dB)
Microphone Impedance	600 Ohms (200 to 10 k Ohms)	600 Ohms (200 to 10 k Ohms)	600 Ohms (200 to 10k Ohms)
Circuit Type	Triple-conversion superheterodyne (SSB/CW/AM) Double-conversion superheterodyne (FM/C4FM)	Double-conversion superheterodyne (SSB/CW/AM/FM) Superheterodyne (WFM)	Double-Conversion Superheterodyne (SSB/CW/AM/FM) Single-Conversion Superheterodyne (WFM)
Intermediate Frequencies	1st. 69.450 MHz 2nd. 9.000 MHz (SSB/CW/AM); 450 kHz (FM/C4FM) 3rd. 24 kHz (SSB/CW/AM)	1st. 68.33 MHz (SSB/CW/AM/FM); 10.7 MHz (WFM) 2nd. 455kHz	1st: 68.33MHz (SSB/CW/AM/FM); 10.7MHz (WFM) 2nd: 455kHz
Sensitivity	SSB/CW (BW: 2.4 kHz, 10 dB S+N/N) 0.158 μV (1.8 - 30 MHz, AMP 2) 0.125 μV (50 - 54 MHz, AMP 2) 0.11 μV (144 - 148 MHz) 0.11 μV (430 - 450 MHz) AM (BW: 6 kHz, 10 dB S+N/N, 30 % modulation @400 Hz) 5 μV (0.5 - 1.8 MHz, AMP 2) 1.6 μV (1.8 - 30 MHz, AMP 2) 1.25 μV (50 - 54 MHz, AMP 2) FM (BW: 15 kHz, 12 dB SINAD) 0.35 μV (28 - 30 MHz, AMP 2) 0.35 μV (50 - 54 MHz, AMP 2) 0.18 μV (144 - 148 MHz) 0.18 μV (430 - 440 MHz) There is no specification for frequency ranges not listed.	SSB/CW (10 dB S+N/N) 0.2 μV (1.8 - 30 MHz), 0.125 μV (50 - 54 MHz), 0.125 μV (144 - 148 MHz/430 - 440 MHz) AM (10 dB S+N/N, 30 % modulation @400 Hz) 32 μV (0.1 - 1.8 MHz), 2 μV (1.8 - 30 MHz), 1 μV (50 - 54 MHz) FM (12 dB SINAD) 0.5 μV (28 - 30 MHz), 0.2 μV (50 - 54 MHz), 0.16 μV (144 - 148 MHz/430 - 440 MHz)	SSB/CW 0.25 μV (1.8 - 28 MHz) 0.25 μV (28 - 30 MHz) 0.2 μV (50 - 54 MHz) 0.125 μV (144/430 MHz bands) AM 32 μV (0.5 - 1.8 MHz) 2 μV (1.8 - 28 MHz) 2 μV (28 - 30 MHz) 2 μV (50 - 54 MHz) FM 0.5 μV (28 - 30 MHz) 0.32 μV (50 - 54 MHz) 0.2 μV (144/430 MHz bands) (IPO, ATT off, SSB/CW/AM = 10dB S/N, FM = 12dB SINAD)
Selectivity	Mode -6 dB -60 dB CW 0.5 kHz or better 0.75 kHz or less SSB 2.4 kHz or better 3.6 kHz or less AM 6 kHz or better 15 kHz or less FM 12 kHz or better 30 kHz or less(-50dB)	Mode -6 dB -60 dB SSB/CW 2.2 kHz 4.5 kHz AM 6 kHz 20 kHz FM 15 kHz 30 kHz FM-N 9 kHz 25 kHz SSB (optional YF-122S installed) 2.3 kHz 4.7 kHz(-66dB) CW (optional YF-122C installed) 500 Hz 2.0 kHz CW (optional YF-122CN installed) 300 Hz 1.0 kHz	(Mode) (-6dB) (-60dB) SSB/CW 2.2kHz 4.5kHz AM 6kHz 20kHz FM 15kHz 30kHz FM-N 9kHz 25kHz SSB 2.3kHz 4.7kHz (-66dB) *optional YF-122S installed CW 500Hz 2.0kHz *optional YF-122C installed CW 300Hz 1.0kHz *optional YF-122CN installed
Image Rejection	70 dB or better (HF / 50 MHz Amateur bands) 60 dB or better (144 / 430 MHz Amateur bands)	70 dB or better (HF / 50 MHz Amateur bands) 60 dB or better (144 / 430 MHz Amateur bands)	70dB or better (HF / 50MHz Amateur bands) 60dB or better (144 / 430MHz Amateur bands)
Maximum Audio Output	2.5 W into 4 Ohms with 10% THD	2.5 W into 4 Ohms with 10% THD or less	1.0W (8 Ohms, 10% THD or less)
Audio Output Impedance	4 to 8 Ohms (4 Ohms: nominal)	4 to 16 Ohms (8 Ohms: nominal)	4 - 16 ohms
Conducted Radiation	Less than 4 nW	Less than 4 nW	less than 4 nW
	* European version only		

● Specifications are subject to change, in the interest of technical improvement, without notice or obligation, and are guaranteed only within the amateur bands.

About this brochure: We have made this brochure as comprehensive and factual as possible. We reserve the right, however, to make changes at any time in equipment, optional accessories, specifications, model numbers, and availability. Precise frequency range may be different in some countries. Some accessories shown herein may not be available in some countries. Some information may have been updated since the time of printing; please check with your Authorized Yaesu Dealer for complete details.

YAESU
The radio

YAESU MUSEN CO., LTD. <http://www.yaesu.com/jp>
Tennozu Parkside Building
2-5-8 Higashi-Shinagawa, Shinagawa-ku, Tokyo 140-0002, Japan

YAESU USA <http://www.yaesu.com>
US Headquarters 6125 Phyllis Drive, Cypress, CA 90630, U.S.A.

YAESU UK <http://www.yaesu.co.uk>
Unit 12, Sun Valley Business Park, Winnall Close
Winchester, Hampshire, SO23 0LB, U.K.

