

YAESU

AIR BAND TRANSCEIVER

FTA-250L

Operating Manual

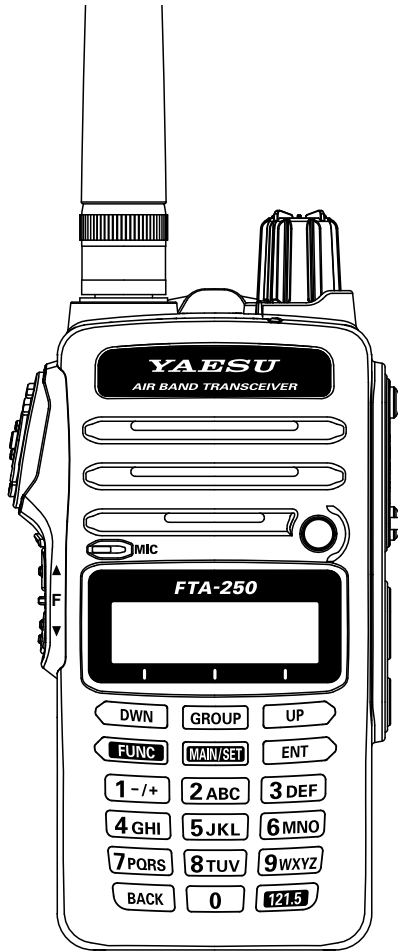

Contents

Introduction	1	Controls & Connectors (Top / Front Panel)	9
Safety Precautions	2	Controls & Connectors (Left / Right Side)	10
Important Notice!	4	Operation	11
Accessories and Options	5	Using comm mode	13
Supplied Accessories	5	Using memory mode	13
Options	5	Reception of Weather Channel Broadcasts	15
Before You Begin	6	Weather alert reception	15
Antenna Installation	6	Function feature	16
Belt Clip Installation	6	Scanning Operation	18
Installing the Battery Pack	6	Memory Scan Skip	19
Removing the Battery Pack	6	Maintenance of the Memory	19
Charging the Battery Pack	7	Dual Watch feature	20
Charging with external power cable	7	Accessing the 121.5 MHz Emergency Frequency	21
Low Battery Indication	7	Adjusting the squelch	22
Quick Guide	8	Key Lock	22
Enter the COMM, MEMORY and WX modes	8	Previous Frequency and Memory Recall Feature	22
Adjust frequency	8	Advanced Operation	23
Store frequencies to memory	8	Enter setup mode	23
Recall a memory channel	8	Summary of the SETUP Menu	24
Recall six frequently used functions	8	Resetting the Transceiver	28
Return to previous operating frequencies or memory channels	8	Headset Connection	28
Call the emergency communication frequency (121.5 MHz)	8	Troubleshooting For Headset Connection	29
		Headset specification requirements for SCU-42	29
		Specifications	30

Introduction

The YAESU **FTA-250L** is ultra compact, stylish, solid hand-held transceivers providing communication (transmit and receive) capability on the International Aircraft Communication Band (“COM” band: 118 to 136.975 MHz).

The **FTA-250L** includes NOAA weather band monitoring and 250 memory channels. The channel configurations can be easily reprogrammed in minutes using the optional PC Programming Software and your PC.

We recommend that you read this manual in its entirety, so as to understand the many features of the **FTA-250L** completely. Keep this manual handy, so you may use it for reference.

Congratulations!

You now have at your fingertips a valuable communications tool, a YAESU two-way radio! Rugged, reliable and easy to use, your YAESU radio will keep you in constant touch with your friends and colleagues for years to come, with negligible maintenance or downtime.

Please take a few minutes to read this manual carefully. The information presented here will allow you to derive maximum performance from your radio, in case questions arise later on.



We're glad you joined the YAESU team. YAESU products cover the entire spectrum of radio communications applications, and our worldwide support network is here to serve you. Let us help you get your message across.

Safety Precautions





Be sure to read the safety precautions to use this product safely.

Yaesu is not liable for failures and other problems caused due to misuse or use of this product by you or a third party. Also, Yaesu is not liable for damages caused through use of this product by you or a third party except in the case where ordered to pay for damages under the laws.



Type and meaning of the marks





-  **DANGER** Indicates an imminently hazardous situation which, if not avoided, could result in death or serious injury.
-  **WARNING** Indicates a potentially hazardous situation which, if not avoided, could result in death or serious injury.
-  **CAUTION** Indicates a potentially hazardous situation which, if not avoided, may result in minor or moderate injury or only property damage.

Type and meaning of symbols







-  Indicates a prohibited action, not to be done in order to use this product safely. For example,  indicates that the product should not be disassembled.
-  Indicates a required action, to be done in order to use this product safely. For example,  indicates that the power plug should be removed.

DANGER

-  **Do not use this product in "an area where use of it is prohibited", e.g., inside the hospital or train.**
This product can affect electronic or medical devices.
-  **Those who are carrying a medical device such as a cardiac pacemaker should not perform transmission near the device. When transmitting, use an external antenna and keep as far as possible away from the external antenna.**
The radio wave emitted by the transmitter can cause the medical device to malfunction and result in an accident.

-  **Do not use this product while riding a bicycle or driving a car. Accidents can result.**
Be sure to stop the bicycle or car at a safe place before using this product.
-  **Do not perform transmission in a crowded place for the safety of persons using a medical device such as a cardiac pacemaker.**
The radio wave emitted from this product can cause the medical device to malfunction and result in an accident.
-  **Do not touch any material leaking from the battery pack with bare hands.**
The chemical that has stuck to your skin or entered your eye can cause chemical burns. In such a case, consult the doctor immediately.
-  **Do not use this product or the battery charger in a place where flammable gas is generated.**
A fire or explosion can occur.
-  **Do not solder or short-circuit the terminal of the battery pack.**
A fire, leak, overheating, explosion, or ignition can result. Do not carry the battery pack together with a necklace, hairpin, or small metal objects. A short circuit can result.

WARNING

-  **Do not power this transceiver with a voltage other than the specified power supply voltage.**
A fire, electric shock, or damage may result.
-  **Do not use the battery pack for any model other than the specified transceiver.**
A fire, leak, overheating, explosion, or ignition can result.
-  **Do not make very long transmissions.**
The main body of the transceiver may overheat, resulting in a failure or burns.
-  **Do not disassemble or make any alteration to this product.**
An injury, electric shock, or failure can result.
-  **Keep the terminals of the battery pack clean.**
If terminal contacts are dirty or corroded, a fire, leak, overheating, explosion, or ignition can result.
-  **Do not handle the battery pack or charger with wet hands. Do not insert or remove the power plug with wet hands.**
An injury, leak, fire, or failure can result.



If smoke or strange odor is emitted from the main body, battery pack, or battery charger, immediately turn the transceiver off; remove the battery pack, and remove the power plug from the outlet. A fire, leak, overheating, damage, ignition, or failure can result. Contact the dealer from which you purchased this product or Yaesu Customer Support.



Do not use the battery pack which is externally damaged or deformed.

A fire, leak, heating, explosion, or ignition can result.



Do not use any battery charger which is not specified by Yaesu.

A fire or failure can result.



When transmitting, keep the transceiver at least 5.0 mm (3/16 inch) away from your body. Use only the supplied antenna. Do not use modified or damaged antennas.



If charging of the battery pack cannot be completed within the specified charging time, immediately remove the power plug of the battery charger from the outlet.

A fire, leak, overheating, explosion, or ignition can result.



CAUTION



Do not dangle or throw this product by holding its antenna.

This product can hit and injure someone. In addition, doing so can result in a transceiver failure or damage.



Do not use transceiver in a crowded place.

The antenna can hit someone, resulting in an injury.



Do not place this transceiver in a place subject to direct sunlight or near a heater.

The transceiver can deform or discolor.



Do not place this transceiver in a humid or dusty place.

A fire or failure can result.



During transmission, keep the antenna as far from you as possible.

Long-time exposure to electromagnetic waves can have a negative impact on your health.



Do not clean the case with thinner or benzene.

Use a soft, dry cloth to clean the case.



If the transceiver is not being used for an extended period, turn it off and remove the battery pack for safety.



Do not drop, strike, or throw the transceiver.

A failure or damage may result.



Keep magnetic cards and videotape away from the transceiver.

The data recorded on cash cards or videotape can be erased.



Charge the battery pack within the temperature range from +5 °C to +35 °C (+41 °F to +95 °F).

Charging the battery pack outside this temperature range can cause leak, overheating, decrease in performance, or reduction in service life can result.



When unplugging the power cord of the battery charger, be sure to hold the power plug.

Pulling the power cord can damage it and cause a fire or electronic shock.



Do not use the earphones or head-phones at an extremely high volume level.

Hearing impairment can result.



Keep this product out of reach of children.

An injury, etc. can result.



Install the belt clip securely.

If they are installed improperly, the FTA-250L may fall or drop, resulting in an injury or damage.



Do not place a heavy object on the power cord of the battery charger.

The battery cord can be dam-aged, resulting in a fire or electric shock.



Do not use the included battery charger to charge any battery pack, which is not specified for use with the charger.

A fire can result.



Do not operate the transmitter near the TV or radio.

Radio disturbance can occur in the transceiver, the TV, or the radio.



Do not use any products other than the specified options and accessories.

A failure can result.



When the battery charger is not in use, remove its power plug from the outlet.



Before discarding the worn battery pack, affix tape or the like to its terminals.



Before using this transceiver in a hybrid or fuel-saving car, be sure to check with the auto-mobile manufacturer regarding use of the transceiver in that car. Noise generated by an onboard electrical device (inverter, etc.) can disrupt the normal operation of the transceiver.



Do not use at extremely low atmospheric pressure.

Important Notice!

FCC RF Exposure Compliance Requirements for Occupational Use Only:

The **FTA-250L** has been tested and complies with the Federal Communications Commission (FCC) RF exposure limits for Occupational Use/Controlled Exposure Environment. In addition, the radio complies with the following Standards and Guidelines:

- ❑ FCC 96-326, Guidelines for Evaluating the Environmental Effects of Radio-Frequency Radiation.
- ❑ FCC OET Bulletin 65 Edition 97-01 (1997) Supplement C, Evaluating Compliance with FCC Guidelines for Human Exposure to Radio Frequency Electromagnetic Fields.
- ❑ ANSI/IEEE C95.1-1992, IEEE Standard for Safety Levels with Respect to Human Exposure to Radio Frequency Electromagnetic Fields, 3 kHz to 300 GHz.
- ❑ ANSI/IEEE C95.3-1992, IEEE Recommended Practice for the Measurement of Potentially Hazardous Electromagnetic Fields - RF and Microwave.
- **This radio is NOT approved for use by the general population in an uncontrolled environment. This radio is restricted to occupational use, work related operations only where the radio operator must have the knowledge to control its RF exposure conditions.**
- **When transmitting, hold the radio in a vertical position with its microphone 1 to 2 inches (2.5 to 5 cm) away from your mouth and keep the antenna at least 1 inch (2.5 cm) away from your head and body.**
- **The radio must be used with a maximum operating duty cycle not exceeding 50%, in typical Push-to-Talk configurations. DO NOT transmit for more than 50% of total radio use time (50% duty cycle). Transmitting more than 50% of the time can cause FCC RF exposure compliance requirements to be exceeded.**
- **Always use YAESU authorized accessories.**

NOTICE

There are no user-serviceable parts inside this transceiver.
All service work must be referred to an Authorized Service Center.

Accessories and Options

Supplied Accessories

Lithium-ion Battery Pack	SBR-25LI
AC Adapter	SAD-26
Charger Cradle	SBH-22
Cigarette Lighter DC/DC Converter	SDD-12
Helical Antenna	SRA-20A ※
Headset Adapter Cable	SCU-42
Belt Clip	SHB-18
Ferrite Core	L9190192
Operating Manual	
Warranty Card	

※ Antenna gain: 2.15 dBi
Impedance: 50 ohms

Options

Speaker Microphone	SSM-20A
Earphone (available only with the SSM-20A)	SEP-10A
Earphone	SEP-11A
Li-Ion Battery Pack (7.4 V, 1,950 mAh)	SBR-25LI
Li-Ion Battery Pack (7.4 V, 2,500 mAh)	SBR-26LI
AC Adapter	SAD-26
Charger Cradle	SBH-22
Cigarette Lighter DC/DC Converter	SDD-12
Helical Antenna	SRA-20A
Belt Clip	SHB-18
Headset Adapter Cable	SCU-42
USB Programming Cable	SCU-37

Availability of accessories may vary. Some accessories are supplied as standard per local requirements, while others may be unavailable in some regions. Consult your YAESU Dealer for details regarding these and any newly available options.

Connection of any non-YAESU-approved accessory, should it cause damage, may void the Limited Warranty for the FTA-250L.

Before You Begin

Antenna Installation

Grasp the base of the antenna firmly, and exert a moderate “pinching” pressure on the base while pressing the antenna onto the transceiver antenna connector.

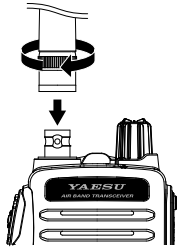

When installing the supplied antenna, never hold the upper part of the antenna while screwing it onto the mating connector on the transceiver. Never transmit without having an antenna connected.



Belt Clip Installation

Attach the belt clip on the back of transceiver using the supplied screws (two).

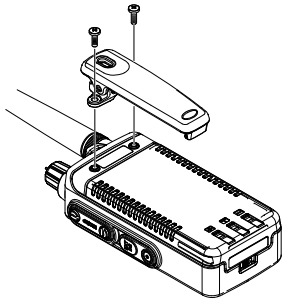

Installing the Battery Pack

1. Insert the battery pack into the battery compartment on the back of the transceiver
2. Push the battery in until the battery latch on the lower back side of the transceiver clicks securely

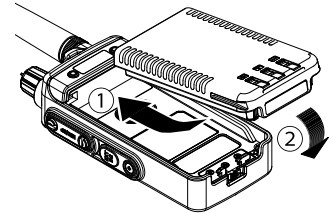

Caution

There is risk of explosion if the battery is replaced with an incorrect type.
Dispose of used batteries according to the instructions.

Removing the Battery Pack

1. While sliding the latch in the direction of the arrow, as shown in the illustration, slide the battery pack downward and out of the transceiver.

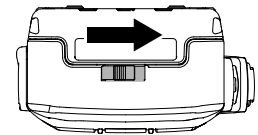

Charging the Battery Pack

- A fully discharged SBR-25LI Battery Pack will be charged completely in about 3.5 hours.
* Depending on the condition of the battery pack, charging time may be longer.
- Turn the transceiver OFF, and place it in the SBH-22 Charging Cradle.
- The SBH-22 LED lights in red and charging starts.
- Charging is completed when the SBH-22 LED lights in green.



Charge the battery pack in a place where the ambient temperature is +41 °F to +95 °F (+5 °C to +35 °C).

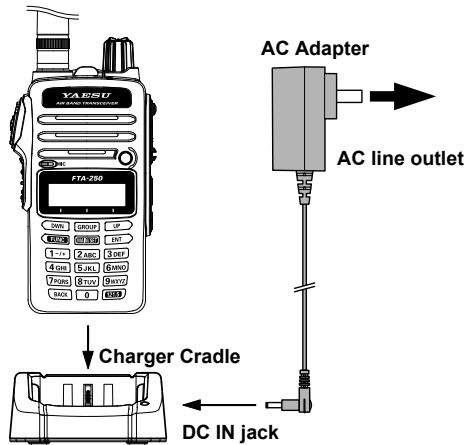

Charging with external power cable

You can also charge (trickle charge) with the supplied external power adapter with cigar plug SDD-12.

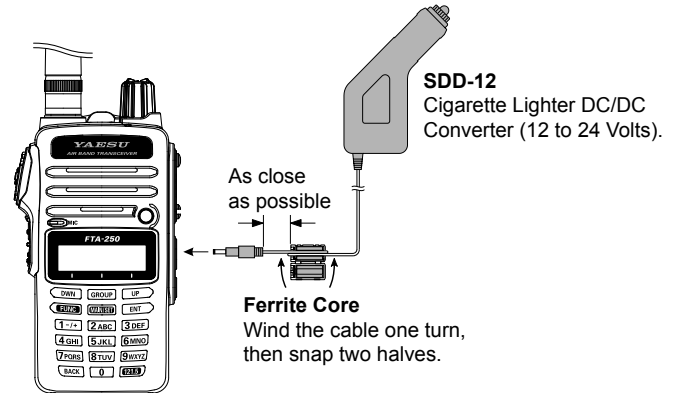

Low Battery Indication

When the battery voltage is too low for reliable operation, the “” icon will blink on the LCD display.



Quick Guide

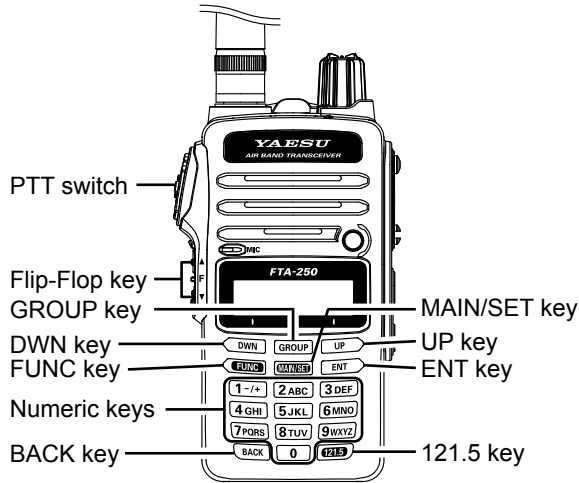

Enter the COMM, MEMORY and WX modes

Press the [MAIN/SET] key, and then press one of the following keys:

[DWN] key ➡ COMM  mode

[GROUP] key ➡ MEMORY  mode

[UP] key ➡ WX  mode

Adjust frequency

- Press the [DWN] or [UP] key.
- Enter the frequency with the numeric keys.

Store frequencies to memory

Tune to the frequency ➡ Press and hold the [ENT] key ➡ Press the [GROUP] key to select the Group ➡ Press the [DWN] or [UP] key to select the Channel ➡ Press and hold the [ENT] key ➡ Press and hold the [ENT] key again.

Recall a memory channel

Press the [GROUP] key ➡ Press the [GROUP] key to select the Group ➡ Press the [DWN] or [UP] key to select the Channel

Recall six frequently used functions

Each time the [FUNC] key is pressed; a function call screen is displayed.

Return to previous operating frequencies or memory channels

Each time the [Flip-Flop] () key on the side is pressed, up to 9 previous operating frequencies and memory channels may be recalled in order.

Call the emergency communication frequency (121.5 MHz)

Holding down the [121.5] key will produce four beeps and enter the emergency frequency mode.

To cancel the emergency mode, press the [BACK] key, then press the [DWN] () key.

Controls & Connectors (Top / Front Panel)

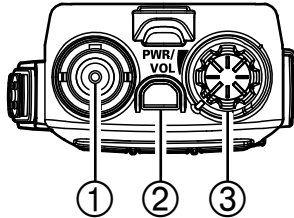

- ① **Antenna Jack (BNC)**
- ② **LOCK Key**
Press and hold to turn the lock function ON/OFF.
- ③ **PWR/VOL Knob**
 - Power ON/OFF
 - Volume adjustment

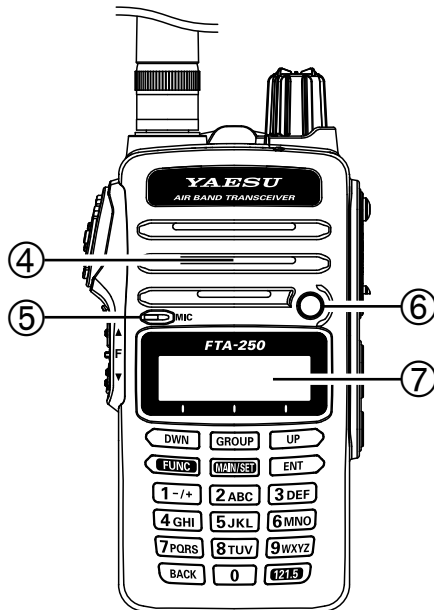

- ④ **Loudspeaker**
- ⑤ **Microphone**
- ⑥ **TX indicator**
Lights red during transmission.
- ⑦ **LCD (Liquid Crystal Display)**
Displays frequency and transceiver status.

Controls & Connectors (Left / Right Side)

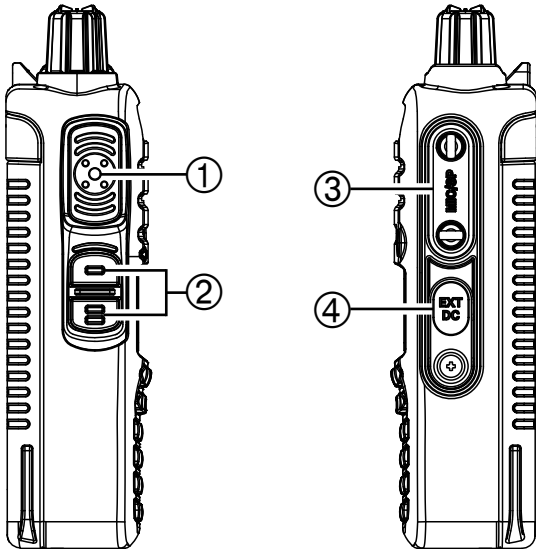

① PTT (Push To Talk) Switch

② Flip-Flop (▲/▼) key

The FTA-250L automatically memorizes up to 9 operating frequencies that may be recalled for later use.

Each press of the lower [▲/▼] key will change the transceiver operation to an earlier saved operating frequency or memory channel. Each press of the upper [▲/▼] key will change the

transceiver operation to a more recently saved operating frequency or memory channel. Press and hold the two keys at the same time to erase the stored information.

③ MIC/SP Jack

The optional SSM-20A Speaker/Microphone or the supplied SCU-42 Headset Adapter Cable may be connected to this jack.

④ EXT/DC Jack

The SDD-12 Cigarette Lighter DC/DC Converter may be connected to this jack.

Operation

Use the [MAIN/SETUP] key to select one of the three operating modes.

1. Press the [MAIN/SET] key.

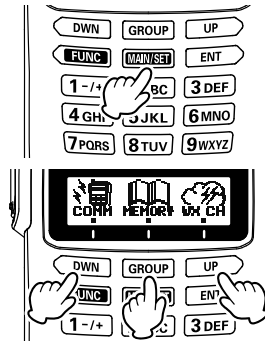

2. Press the key that selects the desired operating mode.

[DWN] key ⇒ COMM  mode

[GROUP] key ⇒ MEMORY  mode

[UP] key ⇒ WX  mode

 **COMM (COMM) mode**

Set the desired frequency and operate.

 **MEMORY (MEMORY) mode**

The 250 memory channels can register frequently used frequencies, which can be recalled for convenient operating.

 **WX CH (WX) mode**

The FTA-250L can receive 10 VHF weather channels to assist with flight planning.

 (COMM) mode

Emblem lights while the dual watch function is operating.



 (MEMORY) mode

Group number
Displays the memory channel group number.

Channel number
Displays the memory channel number.

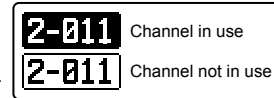

Memory scan will scan only the channels on which this icon is displayed.

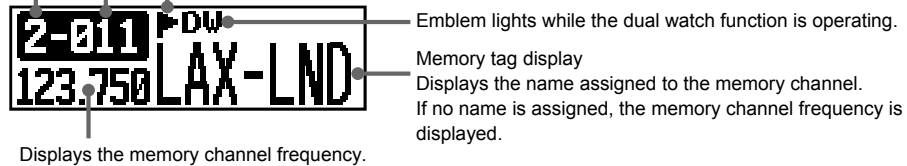

Displays the memory channel frequency.

 (WX) mode

Scans only the weather channels on which this icon is displayed.

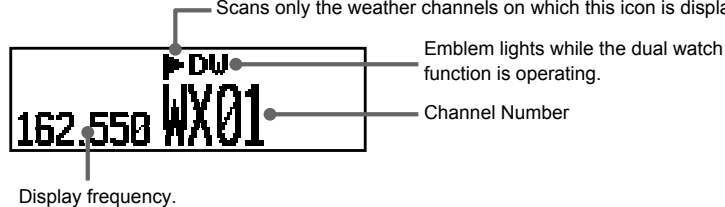

Using comm mode

Adjusting the frequency

- ❑ Press the [DWN] or [UP] key to adjust the frequency.
- ❑ Use the numeric keypad to enter the frequency.

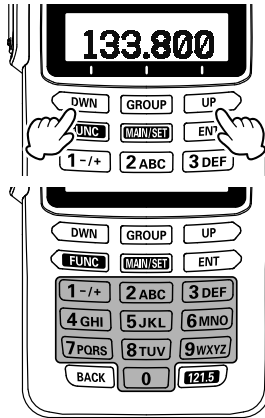

For example, to set 134.35 MHz,
press [1] ➡ [3] ➡ [4] ➡ [3] ➡ [5].

To set 118.275 MHz, it is not necessary to enter the final “5” in the frequency as below:

[1] ➡ [1] ➡ [8] ➡ [2] ➡ [7].

To set 120.000 MHz, press and hold the “2” key button, it is not necessary to enter the “0”s;

[1] ➡ press and hold [2].



- The frequency input may be canceled by pressing the PTT switch before completing the entry.
- Register frequently used frequencies into the memory channels. The memory channel may be easily recalled for later use. (page 14).

Using memory mode

How to enter memory channels

Each memory channel can be given a name of up to 7 characters.

The memories can be divided into 9 groups (1 to 9). Memory channels can be categorized and managed as necessary.

1. In COMM mode, turn to the frequency to be written to memory.

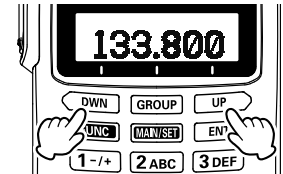

2. Press and hold the [ENT] key.

The group number and unused vacant channel number flashes.

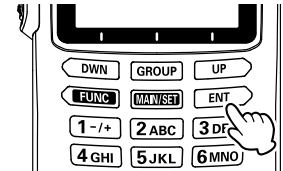

To change the group number, press the [GROUP] key.

To change the channel number, press the [DWN] or [UP] key.

The channel in use is black, and the unused channels are white.

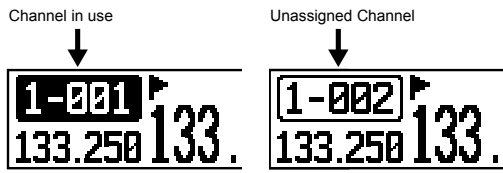

3. Press and hold the [ENT] key.
(When not entering a nametag, go to step 7)
4. Select and enter the nametag characters with the [DWN] / [UP] keys or the numeric keypad.

- Each time the [DWN] or [UP] key is pressed, the characters change as follows:



⇔ 0 to 9 ⇔ A to Z ⇔ symbol ⇔ 0 to 9 ⇔

- Example: Each time the [2] key is pressed the characters change as follows:

2 ⇨ A ⇨ B ⇨ C ⇨ 2 ⇨

5. Press the [ENT] key to move to the right digit.
6. Repeat steps 4 and 5 to complete the nametag.
7. Press and hold the [ENT] key.
Frequency and name are registered and operation is returned to the normal operation screen.

Recalling the Memories

1. Press the [MAIN/SET] key.

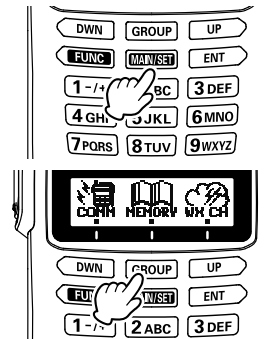

2. Press the [GROUP] (MEMORY) key.
The last tuned memory channel will be received.



Alternately, the last used memory group may be recalled by pressing the [GROUP] key without performing operations 1 and 2 above.

3. Press the [GROUP] key to select a memory group.
4. Press the [DWN] or [UP] key to select a memory channel in the group.
Or press the numeric keypad to enter the memory channel number.

For example, to recall memory channel #005, press [0] ⇨ [0] ⇨ [5].



- Only the memories registered in the current memory group may be selected.
- To switch to another memory group, press the [GROUP] key.

Deleting memory channels

1. Select the memory channel to be erased.
2. Press and hold the [ENT] key.
3. Press the [UP]([DEL]) key.

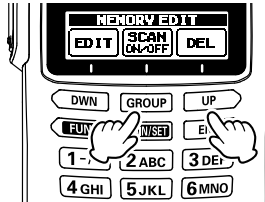

To delete the memory channel ➡ Press the [GROUP]([OK]) key.

To cancel without erasing the memory ➡ Press the PTT switch.

Reception of Weather Channel Broadcasts - Weather Channels for USA/ Canada only -

1. Weather channel can be selected from the pre-programmed list, with the [DWN] or [UP] key.

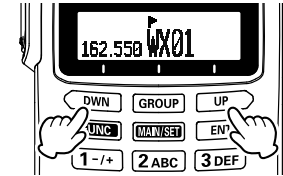

Weather channels can also be recalled by entering frequencies from the keyboard.



WX01: 162.550 MHz	WX06: 162.500 MHz
WX02: 162.400 MHz	WX07: 162.525 MHz
WX03: 162.475 MHz	WX08: 161.650 MHz
WX04: 162.425 MHz	WX09: 161.775 MHz
WX05: 162.450 MHz	WX10: 163.275 MHz

Weather alert reception

In the event of extreme weather disturbances, such as storms and hurricanes, the NOAA (National Oceanic and Atmospheric Administration) sends a weather alert accompanied by a 1050 Hz alarm tone and subsequent weather report on one of the NOAA weather channels.



To enable or disable the auto alarm function when receiving the weather alert signal, change the setting in the COMM SETUP menu. See page 24 for details.

Function feature

Six frequently used functions may be accessed with a simple operation:

1. Press the [FUNC] key.

Pressing the [FUNC] key will alternately display the six functions that are set for the function keys.

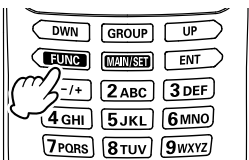

The following functions are set as default from the factory:

- SCAN
- DUAL WATCH
- SQL
- KEY BEEP
- NOISE
- DIM/DISP

2. Pressing the key under the desired function icon will activate the function.

The figure on the right illustrates setting the SQL level.

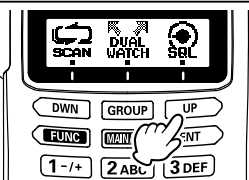

The six default functions and the displayed Icons are described below:



SQL

Setting the squelch level (page 22).



KEY BEEP

Setting the loudness of key beeps.



SCAN

Scan function searches for activate signals on the scanned frequencies or scanned memory channels.



SCAN MEM

Setting whether or not to scan as a memory scan (page 19).



DIM

Setting the level of the display and key lighting when operating the transceiver:

DIM: Lighting continues at the lowest Illumination, even when the keys are operated.



DISP

DISP: keys and display illuminate according to the Setup Mode "BACKLIT" setting.



RX NOISE

The noise cancellation function reduces the receiver background noise that can be heard during signal reception (page 24).



DUAL WATCH

Dual watch function activate.

Periodically checks the preset (PRIORITY-CH) frequency, and receives any active signals on the PRIORITY-CH (page 20).

NONE

- No Function is assigned.

Program the function assigned to the function key



To change a function to be recalled with the [FUNC] key.

1. Press and hold the [MAIN/SET] key \Rightarrow [GROUP] (CON FIG) \Rightarrow Press the [DWN](▼) to select "KEY ASSIGNMENT" \Rightarrow [GROUP](ENT).





2. Press the [DWN](▼) key or [UP](▲) key, to select the function to be changed, then press the [GROUP](ENT) key.
3. Press the [DWN](▼) key or [UP](▲) key, to select the function you want to register newly, then press the [GROUP](ENT) key.
4. Press the PTT switch to return to the normal operation screen.

Scanning Operation

When in COMM mode () or MEMORY mode (), scanning searches for a frequency or memory channel that is receiving a signal.

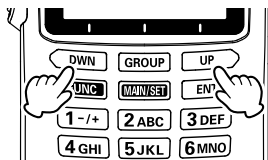
1. Press and hold the [DWN] or [UP] key to start scanning.



- Press and hold the [DWN] key \Rightarrow Scan to lower frequencies.
Press and hold the [UP] key \Rightarrow Scan to higher frequencies
- When shipped from the factory, scanning in the memory mode will scan only the current group, but scanning can be reset to scan the memory channels registered in all groups. For details, refer to "MEMORY SCAN TYPE" on page 24.
- Scanning may also be started by pressing the [FUNC] key, and then pressing the [DWN] () key.
- Scanning will stop temporarily when a signal is received, and the frequency display flashes.

2. To stop scanning, press any key on the keypad.



When weather alert function is ON, scan speed is delayed because scanning also monitors the last used weather channel for the emergency alert signal. Weather alert function is OFF in the factory default.

Example: When the last weather channel is 162.400 MHz (WX02), and the frequency at which scanning is started is 118.000 MHz.











118.000 \Rightarrow **162.400** \Rightarrow 118.025 \Rightarrow
 \Rightarrow **162.400** \Rightarrow 118.050 \Rightarrow **162.400** ...

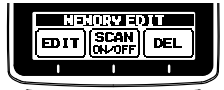

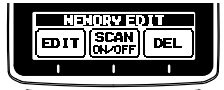

The frequency of the weather channel is not displayed during scanning.

Memory Scan Skip

During memory scanning, you can skip memory channels you do not want to scan.









1. [MAIN/SET] \Rightarrow [GROUP]  \Rightarrow Press the [DWN] / [UP] key to recall the memory channel you want to skip.   
2. Press and hold the [ENT] key.  
3. Press the [GROUP]  key.  
4. Press the [DWN] (▼) or [UP] (▲) key to select “OFF”. 
5. Press and hold the [ENT] key. The change contents are registered, and the changed memory channel is evaluated. 



-  is not displayed \Rightarrow Scanning will be skipped
-  is displayed \Rightarrow Scanning is not skipped

Maintenance of the Memory

The group, channel number, and nametag of the registered memory channel may be changed.

1. Recall the memory channel to be changed. [MAIN/SET] \Rightarrow [GROUP]  \Rightarrow [DWN]/[UP]  
2. Press and hold the [ENT] key.  
3. Press the [DWN]  key. 
4. The group number and the channel number will blink. 



To change the group number, press the [GROUP] key.

To change the channel number, press the [DWN] or [UP] key.

The channel in use is black and the unused channels are white.

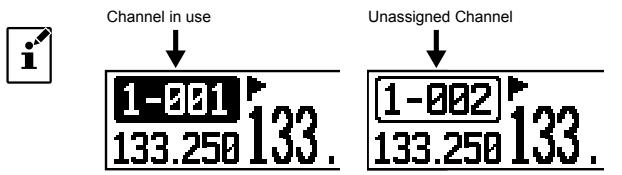

5. Press and hold the [ENT] key.
6. Change the memory nametag.
(If the nametag is not changed, ➡ Go to step 9)
Select the characters with the [DWN] / [UP] key or the numeric keypad.

- Each time the [DWN] or [UP] key is pressed, the characters change as follows:

⇔ 0 to 9 ⇔ A to Z ⇔ symbol ⇔ 0 to 9 ⇔

- Example: Each time you press the [2] key, the letters change as follows.

2 ➡ A ➡ B ➡ C ➡ 2 ➡

7. Press the [ENT] key to move to the right digit.
8. Repeat steps 6 to 7 to complete the nametag.
9. Press and hold the [ENT] key.
Changes are registered and the changed memory channel is displayed.

Dual Watch feature

The previously specified PRIORITY-CH frequency is periodically checked for activity, and a signal on the channel is received.

Setting Priority Channel

1. Press and hold the [MAIN/SET] key.

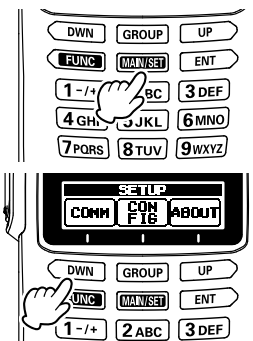

2. Press the [DWN] (**COMM**) key.

3. Press the [DWN](▼) key to select "PRIORITY CH".
4. Press the [GROUP] (**ENT**) key.
5. Enter the frequency you want to check on a regular basis.
6. Press and hold the [ENT] key.
The Priority Channel frequency is set, and the display returns to the setup screen.
7. Press the PTT switch to return to the normal operation screen.

Starting the dual watch

1. Set to the frequency to be constantly received.
2. Press the [FUNC] key, then press the [GROUP] (DUAL WATCH) key will activate the dual watch.

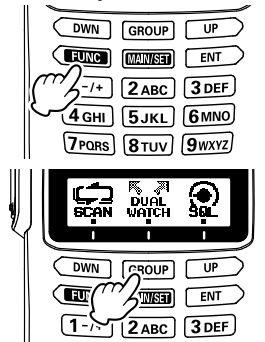

- When there is a signal on PRIORITY CH, the display of frequency flashes, and the signal of PRIORITY CH is received.
- You can also transmit on the PRIORITY CH.
- When the signal on the PRIORITY CH drops out, the dual watch resumes.

3. Press the [FUNC] key, and then press the [GROUP] (DUAL WATCH) key to stop the dual watch function and return to the operation before starting dual watch.

Accessing the 121.5 MHz Emergency Frequency

Access the emergency frequency (121.500 MHz).

1. Hold down the [121.5] key, four beeps will sound and the emergency frequency will be displayed.

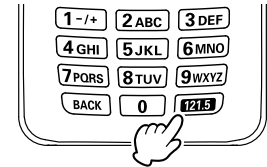

2. To cancel the emergency mode, press the [BACK] key, and then press the [DWN] (YES) key.

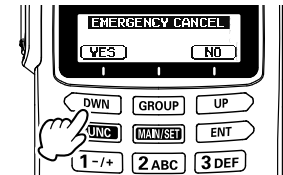
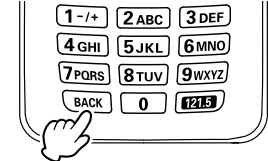

Adjusting the squelch

1. Press the [FUNC] key then press the [UP] key.

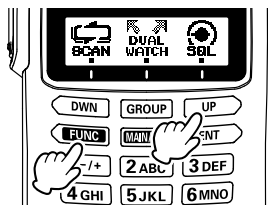

2. Press the [DWN] or [UP] key to adjust to a squelch level (OFF to 15) at which the background noise is muted.

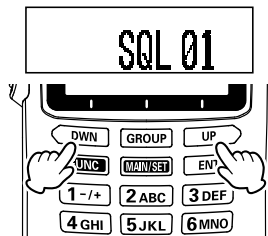

3. Press the [ENT] key to save the squelch setting and return to normal operation.

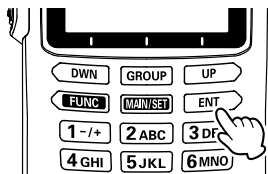

Key Lock

1. Press and hold the LOCK key on the top of the transceiver, "KEY LOCK" will be displayed for about 2 seconds on the display and the front keys will lock.

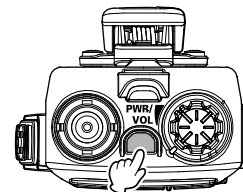

KEY LOCK



The PTT switch, PWR/VOL knob, 121.5 key, and LOCK key cannot be locked.

2. To cancel the lock, press and hold the LOCK key until "UNLOCK" appears on the display.

Previous Frequency and Memory Recall Feature

Up to nine last used frequencies and memory channels are memorized in order. The nine channels can be easily recalled.



Changing the frequency or memory channel will automatically be memorized. When the number stored exceeds 9, the oldest information will be deleted.

1. Pressing the [▲] or [▼] key on the side of the transceiver will recall the memorized frequencies in order.



Press hold the [▲] and [▼] keys at the same time, to delete the memorized frequencies and memory channels.

Advanced Operation

Enter setup mode

1. Press and hold the [MAIN/SET] key.
2. Press any of the [DWN]([COMM]), [GROUP]([CON FIG]), [UP]([ABOUT]) keys.

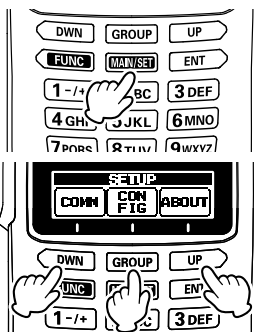

For details, refer to the table on the next page.

- COMM** : Make communication settings
- CON FIG** : Make settings related to the operation of the radio
- ABOUT** : Display firmware version

3. Press the [DWN](▼) or [UP](▲) key to select the item to be set, and then press the [GROUP]([ENT]) key.

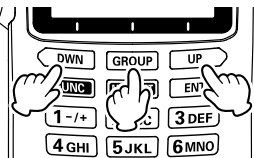

4. Press the [DWN](▼) or [UP](▲) key to change the setting.

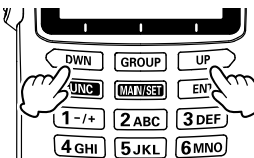

5. Press the [GROUP]([ENT]) key to confirm the setting.

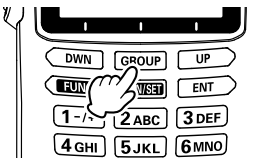

6. Press the PTT switch to return to the normal operation screen.

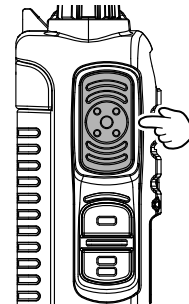

To return to the previous screen, press the [BACK] key to end the operation.

Summary of the SETUP Menu

COMM (COMM SETUP)

Item	Description	Selectable options	Default Value
EMERGENCY CALL	Turn the emergency call ON/OFF	ON / OFF	ON
PRIORITY CH	Frequency setting to monitor regularly with the dual watch function.	-	-
ANL	Automatic Noise Limiter function to reduce impulse noise such as from the engine ignition system.	ON / OFF	OFF
NOISE CANCEL	Reduces background noise during transmission / reception. It can be set individually for transmit and receive.	TX MODE: ON/OFF RX MODE: OFF / LEVEL1 - LEVEL4	TX MODE : OFF RX MODE : OFF
WEATHER ALERT	Sounds a "weather alert" Alarm, and displays a notification on receipt of a signal including a1050Hz tone from NOAA.	ON / OFF	OFF
PTT SCAN STOP	Turning ON/OFF the function to stop scanning by pressing the PTT switch during scanning	ON / OFF	ON
SCAN RESUME	Sets the scanning resume time after scan is temporarily stopped by a received signal.	1 / 2 / 3 / 4 / 5 SEC	3 SEC
SCAN STOP TYPE	Sets the condition of the scan restart after scan is temporarily stopped by a received signal.	BUSY STOP: Resume scanning only after the received signal disappears 5 SEC STOP: Resume scanning after holding on the received signal for 5 seconds 10 SEC STOP: Resume scanning after holding on the received signal for 10 seconds	BUSY STOP
MEMORY SCAN TYPE	Memory channel scan setting to scan only the channels in the current group, or to scan all channels of all the groups.	GROUP: Scan only the channels in the current memory group. ALL: Scan memory channels of all the groups	GROUP
FREQ STEP	Setting the frequency step for tuning (8.33 kHz; Europe only)	25 kHz / 8.33 kHz	25 kHz
TX TOT	"Time Out Timer", Forcibly stops transmission after continuously transmitting for the selected time.	1 / 2 / 3 / 4 / 5 MIN	5 MIN

MIC SELECT	Selection of microphone to be used with the PTT switch of the radio unit.	INTERNAL: When using microphone of transceiver. EXTERNAL: When using an external microphone such as a headset	INTERNAL
SIDE TONE	Adjusting the volume of your voice that you can hear from the headset when using the headset.	OFF / LV1 - LV3 / MAX	OFF
AF PITCH CONT	Tone quality adjustment of received sound.	NORMAL: Output received voice as it is LO CUT: Output reception sound cut low frequency HI CUT: Output received voice cut high frequency HI & LO CUT: Output reception sound cut low and high range	NORMAL
VOX	Turning ON/OFF the function to switch transmission / reception by voice without using the PTT switch while using the headset.	ON / OFF	OFF
VOX LEVEL	VOX function Sensitivity setting to talk to the microphone to send state when operating.	MIN / LV1 / LV2 / LV3 / MAX	LV2
VOX DELAY	Setting of the time until stopping talking and returning to receiving state when VOX function is in operation.	0.5 / 1.0 / 1.5 / 2.0 / 3.0 SEC	1.5 SEC

**CON
FIG** (CONFIG)

Item	Description	Selectable options	Default Value
KEY BEEP	Volume setting of the beep sound that sounds when the key is pressed.	OFF / 1 / 2 / 3 / 4 / 5	3
BATTERY SAVE	The setting of the battery save function that suppresses the consumption of the battery when the signal is not received.	OFF: Disables this function. 50 %: Sleeps for 100 ms after 100 ms awake 70 %: Sleeps for 250 ms after 100 ms awake 80 %: Sleeps for 450 ms after 100 ms awake 90 %: Sleeps for 900 ms after 100 ms awake	50 %
KEY ASSIGNMENT	You can change the function to be called with the [FUNC] key. For details, please refer to "Program the function assigned to the function key" on page 17.	SQL / KEY BEEP / SCAN / SCAN MEM / DIM/DISP / RX NOISE / DUAL WATCH / NONE	1 : SCAN 2 : DUAL WATCH 3 : SQL 4 : KEY BEEP 5 : RX NOISE 6 : DIM/DISP
PTT LOCK	Turning ON/OFF the function to lock the PTT switch so that transmission can not be performed.	ON / OFF	OFF
BACKLIT	Display and key lighting ON/OFF.	ON / OFF	ON
BACKLIT TIMER	Setting of lighting time of display and key lighting.	OFF: No lighting at any time CONTINUOUS: Lights at all time 5/10/30/60/120/300 (sec): Lights for selected time when any key is pressed. EXT PO/KEY: Lights for 5 seconds only when any key is pressed, or lights at all time when the power is supplied through the EXT DC jack.	EXT PO/KEY
CONTRAST	Display contrast setting	LV01 - LV30	LV15

ABOUT (ABOUT)

Item	Description	Selectable options	Default Value
-	Confirming the version of the software	-	-

Resetting the Transceiver

To reset all the settings and memory contents of this transceiver to their initial values (factory default).



Resetting the transceiver will clear all memories. Please make a note of the memories (memory channel settings, etc.) before resetting.

1. Turn off the transceiver.
2. Press and hold the [MAIN/SET] and [ENT] keys while turning the transceiver ON.
3. Reset is complete when the sound “beeps” and the power turns on.

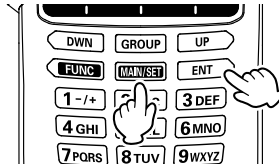

Headset Connection

An optional headset may be connected using the supplied SCU-42 Headset Adapter Cable.

1. Remove the two screws and cover of the MIC/SP jack located on the right side of the transceiver.
2. Insert the plug of the SCU-42 to the MIC/SP jack.
3. Fix the plug with two screws attached to the SCU-42.
4. Insert the plugs of the headset to the sockets of the SCU-42.

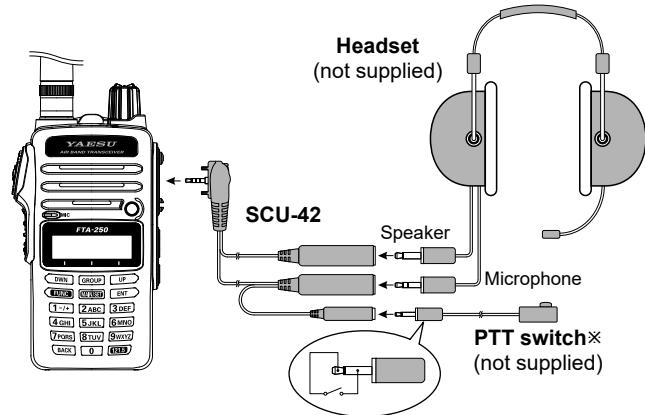

×Please purchasing an aftermarket PTT switch.

Troubleshooting For Headset Connection

Question	Answer
When connecting the SCU-42 headset adapter cable between the radio and a headset, the radio cannot be operated.	This happens when the plug on the SCU-42 headset adapter cable is not properly inserted into the MIC/SP jack. To make proper contact within the radio, the plug must be pushed all the way into the MIC/SP jack and be fixed with the two screws.
Can I purchase the optional PTT Switch from Yaesu?	Contact your Aviation dealer for details regarding purchasing an aftermarket Push-To-Talk switch.
Will my headset work with this radio?	The SCU-42 headset adapter cable is made to operate with most aviation headsets; however to be certain, check with the headset manufacturer using the wiring shown below. Also, confirm the connections and connector sizes are correct.

Headset specification requirements for SCU-42

Earphone (speaker) impedance: 8 Ω or above

Microphone impedance: 150 Ω \pm 20%

PTT pressed: Ground

PTT not pressed: Open

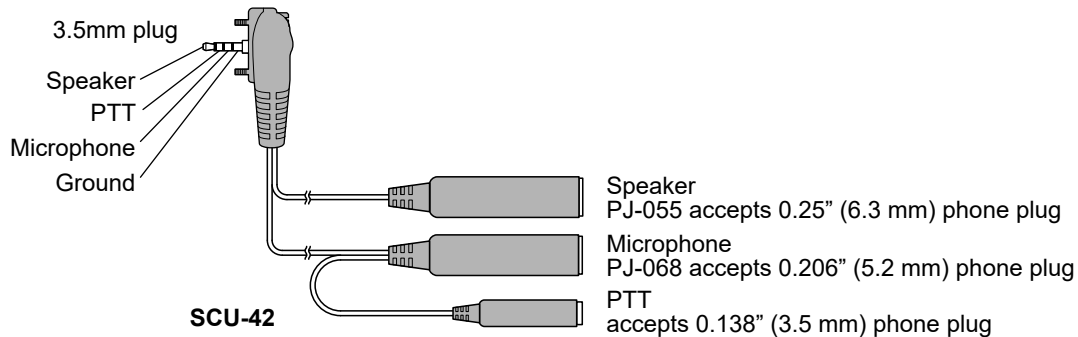

Specifications

General

Frequency Range:	TX: 118.000 to 136.975 MHz RX: 118.000 to 136.975 MHz 161.650 to 163.275 MHz (Weather Channels; USA/Canada only)
Channel Spacing:	25 kHz/8.33 kHz (Europe only)
Emission Type:	TX: AM RX: AM & FM (FM: for receiving the Weather Channels)
Supply Voltage:	6.0 to 9.5 VDC (Battery Terminal) 9.0 to 10.5 VDC (EXT DC JACK with Charging)
Current Consumption (approx.):	300 μ A (power off), 70 mA (battery saver on, saver ratio 50%) 90 mA (squelch on), 300 mA (receive), 900 mA (transmit 1.5 W Carrier) +14 °F to + 140 °F (–10 °C to +60 °C)
Temperature Range:	
Case Size (W x H x D):	2.1 x 4.1 x 1.2 inches (52 x 105 x 30 mm) with SBR-25LI
Weight (approx.):	10.6 oz (300 g) with SBR-25LI, antenna and belt clip

Receiver

Circuit Type:	Double-conversion superheterodyne
IFs:	47.25 MHz & 450 kHz
Sensitivity:	0.8 μ V typ (for 6 dB S/N with 1 kHz, 30 % modulation)
Selectivity:	Better than 8 kHz/–6 dB (25 kHz step) Better than 2.8 kHz/–6 dB (8.33 kHz step)
Adjacent CH. Selectivity:	Less than 25 kHz/–60 dB (25 kHz step) Less than 8.3 kHz/–60 dB (8.33 kHz step)
AF Output (@7.4 V):	0.7 W @ 16 Ohms, 10 % THD

Transmitter

Power Output (@ 7.4 V):	5.0 W (PEP), 1.5 W (Carrier Power)
Frequency Stability:	Better than ± 1 ppm (+14 °F to + 140 °F [–10 °C to +60 °C])
Modulation System:	Low Level Amplitude Modulation
Spurious Emission:	>70 dB below carrier
Int. Microphone Type:	Condenser
Ext Mic. Impedance:	150 Ohms

The fully-charged battery lasts for 16 hours on the transceiver under the conditions below:

Operation ratio ... TX:RX:Standby = 5:5:90 (sec)

Power Output 5 W

Specifications are subject to change without notice or obligation.

This device complies with Industry Canada's license-exempt RSSs. Operation is subject to the following two conditions:

- (1) This device may not cause interference; and
- (2) This device must accept any interference, including interference that may cause undesired operation of the device.

Le présent appareil est conforme aux CNR d'Industrie Canada applicables aux appareils radio exempts de licence. L'exploitation est autorisée aux deux conditions suivantes :

- (1) l'appareil ne doit pas produire de brouillage, et
- (2) l'utilisateur de l'appareil doit accepter tout brouillage radioélectrique subi, même si le brouillage est susceptible d'en compromettre le fonctionnement.

Under Industry Canada regulations, this radio transmitter may only operate using an antenna of a type and maximum (or lesser) gain approved for the transmitter by Industry Canada. To reduce potential radio interference to other users, the antenna type and its gain should be so chosen that the equivalent isotropically radiated power (e.i.r.p.) is not more than that necessary for successful communication.

Conformément à la réglementation d'Industrie Canada, le présent émetteur radio peut fonctionner avec une antenne d'un type et d'un gain maximal (ou inférieur) approuvé pour l'émetteur par Industrie Canada. Dans le but de réduire les risques de brouillage radioélectrique à l'intention des autres utilisateurs, il faut choisir le type d'antenne et son gain de sorte que la puissance isotrope rayonnée équivalente (p.i.r.e.) ne dépasse pas l'intensité nécessaire à l'établissement d'une communication satisfaisante.

This radio transmitter (identify the device by certification number, or model number if Category II) has been approved by Industry Canada to operate with the antenna types listed below with the maximum permissible gain and required antenna impedance for each antenna type indicated. Antenna types not included in this list, having a gain greater than the maximum gain indicated for that type, are strictly prohibited for use with this device.

Le présent émetteur radio (identifier le dispositif par son numéro de certification ou son numéro de modèle s'il fait partie du matériel de catégorie I) a été approuvé par Industrie Canada pour fonctionner avec les types d'antenne énumérés ci-dessous et ayant un gain admissible maximal et l'impédance requise pour chaque type d'antenne. Les types d'antenne non inclus dans cette liste, ou dont le gain est supérieur au gain maximal indiqué, sont strictement interdits pour l'exploitation de l'émetteur.

Part 15.21: Changes or modifications to this device not expressly approved by YAESU MUSEN could void the user's authorization to operate this device.

EU Declaration of Conformity

We, Yaesu Musen Co. Ltd of Tokyo, Japan, hereby declare that this radio equipment FTA-250 is in full compliance with EU Radio Equipment Directive 2014/53/EU. The full text of the Declaration of Conformity for this product is available to view at <http://www.yaesu.com/jp/red>

ATTENTION – Condition of use

This transceiver operates on frequencies that are regulated. Use of the Transmitter in the EU countries shown in the accompanying table is not permitted without authorization. Users should consult their local spectrum management authority for licensing conditions applicable to this equipment.



AT	BE	BG	CY	CZ	DE
DK	ES	EE	FI	FR	EL
HR	HU	IE	IT	LT	LU
LV	MT	NL	PL	PT	RO
SK	SI	SE	CH	IS	LI
NO	-	-	-	-	-

Disposal of Electronic and Electrical Equipment

Products with the symbol (crossed-out wheeled bin) cannot be disposed as household waste.

Electronic and Electrical Equipment should be recycled at a facility capable of handling these items and their waste by products.

Please contact a local equipment supplier representative or service center for information about the waste collection system in your country.



UKCA Declaration of Conformity

We, Yaesu Musen Co. Ltd of Tokyo, Japan declare our sole responsibility that this equipment complies with essential requirements of the Radio Equipment Regulations 2017, Electrical Equipment (Safety Regulations 2016), Electromagnetic Compliance Regulations 2016 and Restrictions of the use of Certain Hazardous Substances in Electrical and Electronic Equipment Regulations 2012 as appropriate.

YAESU

Copyright 2024
YAESU MUSEN CO., LTD.
All rights reserved.

No portion of this manual may be
reproduced without the permission of
YAESU MUSEN CO., LTD.

YAESU MUSEN CO., LTD.

Omori Bellport Building D-3F
6-26-3 Minami-Oi, Shinagawa-ku, Tokyo, 140-0013, Japan

YAESU USA

6125 Phyllis Drive, Cypress, CA 90630, U.S.A.

YAESU UK

Unit 4, Concorde Park, Concorde Way, Segensworth North,
Fareham, Hampshire PO15 5FG, United Kingdom

2404o-KS
Printed in Japan

