

YAESU

Radio for Professionals

C4FM/FM 144/430MHz
DUAL BAND DIGITAL TRANSCEIVER

FTM-500DR

FTM-500DE

Advance Manual



Contents

Digital Personal ID (DP-ID) feature	6
About the Digital Personal ID (DP-ID) feature	6
Registering the DP-ID to a DR-2X digital repeater	6
DR-2X Remote Control Feature	6
Registering the DP-ID of other stations	6
Deleting a registered DP-ID	8
Communicating with specified stations in the Analog FM mode .	9
Selecting the squelch type in the analog FM mode	9
Tone squelch feature	10
Setting CTCSS Tone frequency	10
Searching for the CTCSS Tone transmitted by the other Station	10
Digital Code Squelch (DCS) feature	11
Setting the DCS CODE	11
Searching for the DCS Code Used by the Other Station	11
New Two-Tone CTCSS Pager Function	12
Using the Pager Function	12
Setting the Code for this Station	12
Receiving “Pager Code” calls from a Remote Station (Standby Operation) ...	13
Notification of a Call from a Remote Station by the Bell Function	13
Convenient memory function	14
Programmable Memory Channel Scan (PMS)	14
Registering to the Programmable Memory Channels	14
Performing Programmable Memory Channel Scan	14
Receiving Weather Broadcast Channels	15
Assigning the “WX” function to a programmable key on the microphone	15
Recalling the weather channels	15
Listening with weather alert	15
DTMF Operation	16
Registering the DTMF memory	16
Setting the auto dialer function	16
Transmitting DTMF code automatically using DTMF memory	16
Manually Transmitting the DTMF Code	16
Using the GPS Function	17
Positioning Using GPS	17
Smart Navigation Function	18
Real-Time Navigation Function	18
Backtrack Function	18
Saving GPS Information (GPS Log Function)	20
Checking Tracks on Your PC	20
GPS Screen Information and Operation	21
Measuring the altitude	22

Functions used as needed	23
Timer / Clock function	23
Using the lap timer	23
Using the countdown timer	24
Using the Voice Guide unit FVS-2	25
Mounting the voice guide unit “FVS-2”	25
Using the voice memory	26
Setting the voice memory operation	26
Recording the receive audio	27
Replaying the recorded audio	27
Selecting the track	27
Erasing the recorded audio	27
Voice announcement of the operating frequency	28
Setting the announce function operation	28
Voice announcement of the operating frequency	29
Copying the Radio Data to another Transceiver	30
Connecting an external device	31
Connecting to a computer	31
Transmitting GPS location information	32
Using the transceiver for packet communications	33
Updating the transceiver firmware	35
Setup Menu	36
Setup Menu Operation	36
Tables of Setup Menu Operations	37
Setup Menu Operations	45
DISPLAY	45
1 FREQUENCY INPUT	45
2 LCD BRIGHTNESS	45
3 FREQUENCY COLOR	45
4 BAND SCOPE	45
5 LOCATION INFO	45
6 COMPASS	46
7 DISPLAY MODE	46
TX	47
8 TX POWER	47
9 AMS TX MODE	47
10 MIC GAIN	47
11 VOX	47
12 AUTO DIALER	48
13 TOT	48
14 DIGITAL VW	48
RX	49
15 FM BANDWIDTH	49
16 RX MODE	49
17 SUB BAND	49
18 AUDIO EQUALIZER	50

MEMORY	51
19 HOME CH.....	51
20 MEMORY LIST.....	51
21 MEMORY LIST MODE.....	51
22 PMG.....	51
CONFIG.....	52
23 BEEP	52
24 BAND SKIP	52
25 RPT ARS	52
26 RPT SHIFT	52
27 RPT SHIFT FREQ.....	52
28 RPT REVERSE	53
29 MIC PROGRAM KEY.....	53
30 DATE&TIME ADJUST	53
31 DATE&TIME FORMAT	53
32 TIME ZONE.....	53
33 STEP	54
34 CLOCK TYPE.....	54
35 UNIT	54
36 APO	54
37 GPS DATUM	54
38 GPS DEVICE	55
39 GPS LOG	55
AUDIO	56
40 RECORDING	56
41 REC/STOP	56
42 FRONT SP MUTE	56
SIGNALING	57
43 DTMF.....	57
44 DTMF MEMORY	57
45 SQL TYPE	57
46 TONE SQL FREQ / DCS CODE	57
47 SQL EXPANSION.....	57
48 PAGER CODE.....	57
49 PR FREQUENCY.....	58
50 BELL RINGER.....	58
51 WX ALERT	58
SCAN	59
52 SCAN.....	59
53 DUAL RCV MODE	59
54 DUAL RX INTERVAL.....	59
55 PRIORITY REVERT	59
56 SCAN RESUME	59
DIGITAL.....	60
57 DIGITAL POPUP	60
58 LOCATION SERVICE	60
59 STANDBY BEEP	60

GM	61
WIRES-X	61
DATA	62
69 COM PORT	62
70 DATA BAND	63
71 DATA SPEED	64
72 DATA SQL	65
APRS	66
SD CARD	67
107 BACKUP	67
108 MEMORY INFO	67
109 FORMAT	67
OPTION	68
111 Bluetooth	68
112 VOICE MEMORY	68
113 FVS REC	68
114 TRACK SELECT	68
115 FVS PLAY	68
116 FVS STOP	68
117 FVS CLEAR	68
118 VOICE GUIDE	68
CLONE	69
RESET	69
121 CALLSIGN	69
122 MEMORY CH RESET	69
123 APRS RESET	69
124 CONFIG SET	69
125 CONFIG RECALL	70
126 SOFTWARE VERSION	70
127 FACTORY RESET	70
Appendix	71
The folder configuration of the micro-SD card	71
Maintenance	72
Care and maintenance	72
Replacing the fuse	72
Troubleshooting	73
There is no power	73
There is no sound	73
There is no transmission	73
The keys or knobs do not operate	73

Digital Personal ID (DP-ID) feature

About the Digital Personal ID (DP-ID) feature

When operating in digital C4FM communications, each transceiver is programmed with, and sends its own individual ID information (Radio ID) in each transmission. The DP-ID function and the individual identification information, makes possible group communications between stations that are within communications range. The Digital Personal ID (DP-ID) feature opens the speaker audio only when a signal set to the same DP-ID in the Digital Mode is received, even if each transceiver is set to a different Digital Group ID (DG-ID) number.



To utilize this function, Digital C4FM mode transceivers compatible with the DG-ID function are required.

Registering the DP-ID to a DR-2X digital repeater

After registering the transceiver's DP-ID to the DR-2X repeater, the settings and functions of the DR-2X can be remotely controlled. Remote control cannot be performed from a transceiver that has not been registered with the DP-ID, so it is possible to securely manage repeaters. The transceiver with DP-ID registered in DR-2X is allowed preferential access in an emergency, even when used without the DG-ID setting.



To register the transceiver DP-ID in the DR-2X C4FM digital repeater, refer to the DR-2X instruction manual.

DR-2X Remote Control Feature

To display the FTM-500D remote-control screen while in C4FM digital mode, press and hold the [*] key on the microphone. To return to normal mode, press the [*] key on the microphone. For details on the remote-control function of the DR-2X, refer to the DR-2X instruction manual.

- Activate the repeater operation
- Deactivate the repeater operation
- Set the repeater to C4FM mode
- Set the transmit power
- Voice Message Control (Rec / Play / Stop)
- Set the Emergency Call

Registering the DP-ID of other stations



- Once registered, the DP-ID is stored until deleted.
- Register each other's DP-ID with nearby transceivers.
- When setting the DG-ID code to "00", the transceiver will receive signals from all digital C4FM stations. To utilize the DP-ID function, it is necessary to set the receive DG-ID code to a number other than "00".

1. Press and hold the **FUNC** knob → **[60 DP-ID LIST]** → Press the **FUNC** knob
 - The DP-ID list is displayed.
 - If several DP-IDs are displayed, rotate the **FUNC** knob to register the desired DP-ID.

2. A transmission in the digital C4FM mode from another transceiver will register the DP-ID.

When a signal from the other station is received, the call sign and “Registration” are displayed on the LCD.



- When a signal from another registered transceiver is received, nothing is displayed on the LCD.
- When a transceiver is previously registered with a different call sign, the DP-ID listing is changed to the newly registered call sign.

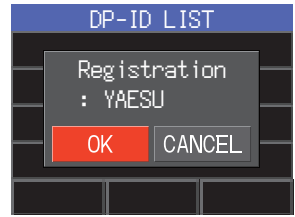

3. Press the **FUNC** knob to save the setting.

- When registering the DP-ID is complete, the display returns to the DP-ID list screen.
- If not registering a DP-ID, rotate the **FUNC** knob to select “**CANCEL**” then press the **FUNC** knob.
- If registering several DP-IDs, repeat step 2 and 3.
- A maximum of 24 stations may be registered.

4. Press the **DIAL** knob, **SUB DIAL** knob or **PTT** switch to finish the setting and return to the original screen.

- All the other communicating stations should similarly register the DP-IDs to the DP-ID lists of their transceivers.
- The DP-ID setting is complete.



To communicate using the DP-ID function, register the DP-ID of each other's transceiver on both transceivers. By registering the DP-ID, users may communicate even if the Digital group ID (DG-ID) is a different setting.

The transceivers may communicate even if the Digital Group ID (DG-ID) is a different setting because Station **A** and station **B** have registered each other's DP-IDs on both transceivers.

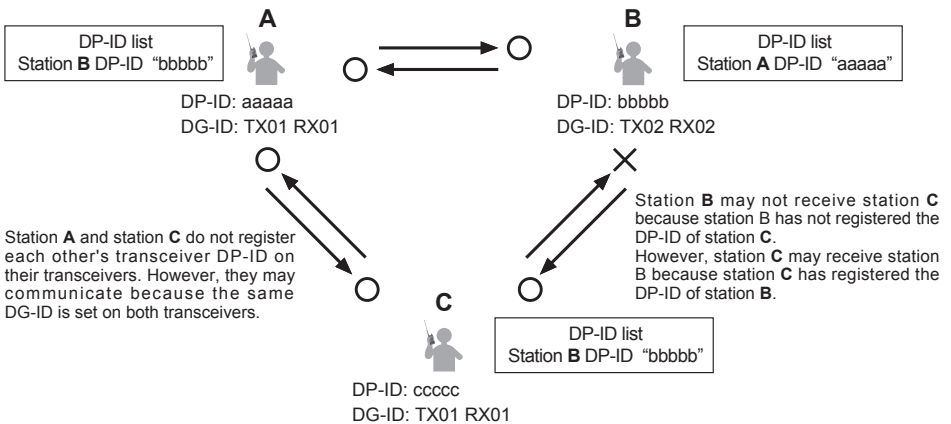

Deleting a registered DP-ID

1. Press and hold the **FUNC** knob → [60 DP-ID LIST] → Press the **FUNC** knob
The DP-ID list is displayed.



2. Rotate the **FUNC** knob to select the call sign of the other transceiver, then press the **SUB DIAL** knob.
3. Press the **SUB DIAL** knob.
Confirmation screen "DELETE?" is displayed.



4. Rotate the **SUB DIAL** knob to select [OK] then press the **SUB DIAL** knob to delete.
 - If not deleting in the DP-ID list, select [CANCEL] then press the **SUB DIAL** knob.
 - If deleting several DP-IDs, press the **SUB DIAL** knob, then repeat step 2 and 3.
5. Press the **DIAL** knob, **SUB DIAL** knob or **PTT** switch to finish the setting and return to the original screen.

Communicating with specified stations in the Analog FM mode

Selecting the squelch type in the analog FM mode

1. Press the **FUNC** knob → **[SQL]** → Press the **FUNC** knob or press and hold the **FUNC** knob → **[45 SQL TYPE]**
2. Rotate the **FUNC** knob to select the type of squelch, refer to the table below.
3. Press the **DIAL** knob, **SUB DIAL** knob or **PTT** switch to finish the setting and return to the original screen.

KEYPAD	HOME CH
SCAN	TXPWR HIGH
SQL OFF	ARS AUTO
RPT-R	TONE 100.0
DTMF	APRS OFF
OFF	



Tone squelch (CTCSS), DCS and the New PAGER (EPCS) functions do not operate in the C4FM digital mode. Press the **[DX]** key to change to the Analog FM mode, or turn the AMS function ON.

Squelch type	Description
OFF	Deactivates the CTCSS and DCS functions. Returns to the normal squelch operation in the Analog FM mode.
T-ENC (TONE ENC)	Activates the CTCSS tone for Analog FM Transmissions. Receives with normal squelch operation.
T-SQL (TONE SQL)	Activates the CTCSS tone squelch function on Analog FM receive.
REV-T (REV TONE)	Activates the reverse tone function. Used to monitor communications based on the squelch control system. When a signal contains the designated tone, the squelch is not opened, and when the tone signal disappears, the squelch opens, and communication starts.
DCS	Activates the Digital Code Squelch (DCS) function. The DCS code may be selected from 104 codes (from 023 to 754).
PRFRQ (PR FREQ)	Activates the no-communication squelch function for radios. The no-communication signal tone frequencies may be specified within the range of 300 Hz to 3000 Hz in steps of 100 Hz.
PAGER	Activates a new two-tone CTCSS pager function. When communicating with transceivers among friends, specify personal codes (each code is composed of two tones) so that only specific stations are called.
D-ENC* (DCS ENC)	Transmits the signal containing the DCS CODE. Receives as a normal squelch operation.
T-DCS* (TONE DCS)	Sends a tone signal when transmitting, and receives only signals with a matching DCS code.
D-TSQ* (DCS TSQ)	Sends a DCS CODE when transmitting and receives only signals that contain a matching tone signal when receiving.

* Press and hold **FUNC** knob → **[47 SQL EXPANSION]** → Press the **FUNC** knob to access “ON”, “D-ENC (DCS ENC)”, “T-DCS (TONE DCS)” and “D-TSQ (DCS TSQ)” setting values are activated.



- The squelch type may be set for each frequency band (BAND).
- The CTCSS and DCS squelch settings are also active during scanning. If scanning is performed with the CTCSS and DCS squelch function activated, scanning stops only when a signal containing the specified CTCSS tone or DCS code is received.
- Pressing the program key on the microphone to which the “SQL OFF” function is assigned, allows all signals that do not contain a tone or DCS code, and signals with different tones, DCS codes, digital mode signals to all be heard.

Tone squelch feature

The tone squelch opens the speaker audio only when a signal containing the specified CTCSS tone is received. The receiver will be quiet while waiting for a call from a specific station.



The Tone Squelch does not function in digital mode. Press the [DX] key to change from Digital, to Analog FM or to AMS function.

Setting CTCSS Tone frequency

The tone may be selected from 50 frequencies (67.0 Hz to 254.1 Hz).

1. Press the **FUNC** knob → [SQL] → Press the **FUNC** knob
2. Rotate the **FUNC** knob to select [T-SQL] then press the **FUNC** knob.
3. Rotate the **FUNC** knob to select [TONE] then press the **FUNC** knob.
4. Rotate the **FUNC** knob to select the tone frequency.
5. Press the **FUNC** knob to finish the setting and return to the previous screen.

KEYPAD	HOME CH
SCAN	TXPWR HIGH
SQL T-SQL	ARS AUTO
RPT-R	TONE 100.0
DTMF	APRS OFF
100.0 Hz	



- The tone frequency setting is common with the squelch types as follows: “T-ENC (TONE ENC)”, “T-SQL (TONE SQL)”, “REV-T (REV TONE)”, “T-DCS (TONE DCS)”, “D-TSQ (DCS TSQ)”
- The default setting is “100.0 Hz”

Searching for the CTCSS Tone transmitted by the other Station

Search and display the CTCSS tone transmitted by the other station.



- Tone search does not function in digital mode. Press the [DX] key to change from Digital to Analog FM or the AMS function.
- To set the transceiver operation when scanning stops, press and hold the **FUNC** knob → [56 SCAN RESUME] → press the **FUNC** knob. This setting is common with the scan setting, tone search function and DCS search function.

1. Press the **FUNC** knob → [SQL] → Press the **FUNC** knob
2. Rotate the **FUNC** knob to select [T-SQL] then press the **FUNC** knob.
3. Rotate the **FUNC** knob to select [TONE] then press the **FUNC** knob.
4. Press and hold the microphone [UP] or [DWN] switch.
 - The transceiver begins searching for a matching tone frequency.
 - When a corresponding tone frequency is detected, the searching stops and the audio is heard.
 - Press the **PTT** switch or the [UP] or [DWN] switch to stop searching.
5. Press the **PTT** to save the detected tone frequency and return to normal operation.

Digital Code Squelch (DCS) feature

The Digital Code Squelch opens the speaker audio only when a signal containing the specified DCS code is received. The DCS code may be selected from 104 types (from 023 to 754).



The DCS Squelch does not function in digital mode. Press the [DX] key to change from Digital to Analog FM or AMS mode.

Setting the DCS CODE

1. Press the **FUNC** knob → [SQL] → Press the **FUNC** knob
2. Rotate the **FUNC** knob to select [DCS] then press the **FUNC** knob.
3. Rotate the **FUNC** knob to select [DCS] then press the **FUNC** knob.
4. Rotate the **FUNC** knob to select the DCS code.
5. Press the **FUNC** knob to finish the setting and return to the original screen.

KEYPAD	HOME CH
SCAN	TXPWR HIGH
SQL DCS	ARS AUTO
RPT-R	DCS 023
DTMF	APRS OFF
023	



- The DCS code set in the above operation is common for all transmissions with a DCS Code (“DCS”, “D-ENC (DCS ENC)”, “T-DCS (TONE DCS)”, “D-TSQ (DCS TSQ)”).
- The default DCS code is “023”.

Searching for the DCS Code Used by the Other Station

Search for the DCS code used by the other station.



- The DCS search does not function in digital mode. Press the [DX] key to change from Digital to Analog FM or AMS mode.
- To set the transceiver operation when scanning stops, press and hold the **FUNC** knob → [56 SCAN RESUME]. This setting is common with the scan setting, tone search and DCS search functions.

1. Press the **FUNC** knob → [SQL] → Press the **FUNC** knob
2. Rotate the **FUNC** knob to select [DCS] then press the **FUNC** knob.
3. Rotate the **FUNC** knob to select [DCS] then press the **FUNC** knob.
4. Press and hold the Microphone [UP] or [DWN] switch.
 - The transceiver begins searching for a matching DCS code.
 - When a corresponding DCS code is detected, the searching stops and the audio is heard.
 - Press the **PTT** switch or the [UP] or [DWN] switch to stop searching.
5. Press the **PTT** switch to save the detected DCS code and return to normal operation.

New Two-Tone CTCSS Pager Function

When using **FTM-500DR/DE** transceivers with a group of friends, setting the Two-Tone CTCSS personal codes allows calling just the specific stations. Even when the person who is called is not near the transceiver, the information on the LCD indicates that a call was received.



The new two-tone CTCSS pager feature does not operate in digital mode. Press the **[D X]** key to change from Digital to Analog FM or the AMS function.

Using the Pager Function

1. Press the **FUNC** knob → **[SQL]** → Press the **FUNC** knob
2. Rotate the **FUNC** knob to select **[PAGER]** then press the **FUNC** knob.
3. Press the **DIAL** knob, **SUB DIAL** knob or **PTT** switch to finish the setting and return to the original screen.

Setting the Code for this Station

Set the “pager code” to be called by other stations.

1. Activate the pager function (refer to “Using the pager function” above).
2. Press and hold the **FUNC** knob → **[48 PAGER CODE]** → Press the **FUNC** knob
3. Rotate the **FUNC** knob to select **[RX CODE 1]** then press the **FUNC** knob.

SIGNALING	
48 PAGER CODE	
RX CODE 1	05
RX CODE 2	47
TX CODE 1	05
TX CODE 2	47

4. Rotate the **FUNC** knob to select the RX CODE 1 of the code from 01 to 50.
5. Press the **FUNC** knob.

SIGNALING	
48 PAGER CODE	
RX CODE 1	05
RX CODE 2	47
TX CODE 1	05
TX CODE 2	47

6. Rotate the **FUNC** knob to select **[RX CODE 2]** then press the **FUNC** knob.
7. Rotate the **FUNC** knob to select the RX CODE 2 of the code from 01 to 50.

The same code cannot be used for RX CODE 1 and RX CODE 2.

SIGNALING	
48 PAGER CODE	
RX CODE 1	05
RX CODE 2	47
TX CODE 1	05
TX CODE 2	47

Next, set the pager code for directing a call to a specific partner station.

8. Rotate the **FUNC** knob to select **[TX CODE 1]** then press the **FUNC** knob.
9. Rotate the **FUNC** knob to select the TX CODE 1 of the codes from 01 to 50.
10. Press the **FUNC** knob.

11. Rotate the **FUNC** knob to select [TX CODE 2] then press the **FUNC** knob.
12. Rotate the **FUNC** knob to select the TX CODE 2 of the codes from 01 to 50.
The same code cannot be used for TX CODE 1 and TX CODE 2.
13. Press any key (except Power Switch) or **PTT** switch to finish the setting and return to the original screen.
14. Press the **PTT** switch to transmit a call to the specific station.



- The reverse combination works as the same code, that is “05 47” is the same as “47 05”.
- If the same code is specified for all individuals, all the individuals can be called at the same time.
- The default code is “05 47”.
- When receiving the codes, the sound of the tones may be heard intermittently.

Receiving “Pager Code” calls from a Remote Station (Standby Operation)

When the Pager function is activated, the audio of received calls with a corresponding Pager Code is heard.

Furthermore, when the Bell function (see below) is activated, the bell rings when receiving calls from the other station.

Notification of a Call from a Remote Station by the Bell Function

The Bell may be set to sound an Alert when a call from another station containing a corresponding tone, DCS or pager code is received.

1. Press and hold the **FUNC** knob → [50 BELL RINGER] → Press the **FUNC** knob
2. Rotate the **FUNC** knob to select the desired number of times (1 - 8 times or continuous) the Bell rings.
OFF / 1 time / 3 times / 5 times / 8 times / CONTINUOUS



If the setting is “CONTINUOUS”, the bell keeps sounding until an operation is made.

SIGNALING	
47	SQL EXPANSION
48	PAGER CODE >
49	PR FREQUENCY
50	BELL RINGER
OFF	

3. Press the **PTT** switch to finish the setting and return to the original screen, the “📶” icon appears on the display.

Convenient memory function

Programmable Memory Channel Scan (PMS)

Registering to the Programmable Memory Channels

50 sets of PMS memory channels (L01/U01 to L50/U50) are available.

- Register the lower and upper frequencies of the frequency range in a pair of Programmable Memory Channels.

L nn: Lower limit memory channel

U nn: Upper limit memory channel

- PMS memory channels are displayed between channel 999 and channel 001. On the Memory Channel List screen, press the **[A]** key on the microphone to jump the “L01” PMS Memory Channel.
- For more details on registering frequencies to the memory channels, see “Writing to Memory” in the Operating Manual.



- Make sure to use the corresponding numbers for the lower and upper limit memory channels.
- Set the Programmable Memory scanning (PMS) lower and upper limits as follows:
 - The lower and upper limit memory channels must be within the same frequency band.
 - The lower and upper limit memory channels must not be registered in reverse.

Performing Programmable Memory Channel Scan

The programmable memory channel scan allows scanning a specified frequency range within the same frequency band.

1. Press the **[V/M mw]** key to enter the memory mode.
2. Recall the PMS memory channel to which the lower limit (Lnn) or upper limit (Unn) of the frequency band is registered.
3. Press and hold the **[UP]** or **[DWN]** switch of the microphone.
 - Programmable memory channel scanning starts.
 - Pressing the program key on the microphone set to the “SCAN” function also starts the PMS scan operation.
 - If the **DIAL** knob is rotated while scanning is in progress, the scanning will continue up or down in frequency according to the direction of the **DIAL** knob rotation.

If the scanner halts on an incoming signal, the frequency will blink. Scanning will resume in about five seconds.

4. Press the **PTT** switch or the **[UP]** or **[DWN]** switch on the microphone, to cancel the scanning.

In this state (displayed as “PMS” at the upper left of the display), the frequency can be changed only in the range stored by the lower and upper PMS memories, by rotating the **DIAL** knob.

● Disable the PMS function

1. Press the **[V/M mw]** key.
Returns to the normal memory mode.

Receiving Weather Broadcast Channels

This transceiver includes the preprogrammed VHF Weather Broadcast Station Memory Channel Bank, and can receive the broadcast or the weather alert by recalling or scanning a desired channel.

The following channels are stored in the transceiver weather station memory bank:

Channel No.	Frequency	Channel No.	Frequency
WX-01	162.550 MHz	WX-06	162.500 MHz
WX-02	162.400 MHz	WX-07	162.525 MHz
WX-03	162.475 MHz	WX-08	161.650 MHz
WX-04	162.425 MHz	WX-09	161.775 MHz
WX-05	162.450 MHz	WX-10	163.275 MHz

This “WX” function can only be utilized when it is assigned to a programmable key [P1] to [P4] on the microphone.

In the USA version of FTM-500DR, “WX” function is assigned to P4 by factory setting.

Assigning the “WX” function to a programmable key on the microphone

1. Press and hold the **FUNC** knob.
2. Rotate the **FUNC** knob to select [**29 MIC PROGRAM KEY**] then press the **FUNC** knob.
3. Rotate the **FUNC** knob to select the [P1], [P2], [P3] or [P4] key to assign a function, then press the **FUNC** knob.
4. Rotate the **FUNC** knob to select [**WX**] then press the **FUNC** knob.
5. Press the **DIAL** knob, **SUB DIAL** knob or **PTT** switch to finish the setting and return to the original screen.

Recalling the weather channels

Example: When “WX” is assigned to [P4]

1. Press [**P4**] on the microphone.
The WX function is activated, and the weather channel selected last time the WX function was activated will be displayed on the screen.
2. Rotate the **DIAL** knob to select the other channels.
3. Press the **PTT** switch on the microphone to search for additional WX stations.
Scanning of the channels stored in the weather station memory bank will start. When the scanning pauses on a station, press the **PTT** switch once to halt the scan, or press it twice to restart the scan.
4. Press the **PTT** switch to finish the scan.
5. Press [**P4**] on the microphone.
The WX function will be inactivated and the display will return to the previous screen.

Listening with weather alert

In the event of extreme weather disturbances, such as storms and hurricanes, the NOAA (National Oceanic and Atmospheric Administration) sends a weather alert accompanied by a 1050 Hz tone and a subsequent weather report on one of the NOAA weather channels. Receiving the weather alert tone may be disabled [**51 WX ALERT**] in the Setup Menu.

DTMF Operation

DTMF (Dual Tone Multi Frequencies) are the tone signals sent to make telephone calls, or control repeaters and network links. Up to 10 registers of 16-digit DTMF tone codes can be stored as telephone numbers to make calls through the public telephone network using a phone patch or to connect through the WIRES-X analog node station.

Registering the DTMF memory

1. Press and hold the **FUNC** knob → [44 DTMF MEMORY] → Press the **FUNC** knob
2. Rotate the **FUNC** knob to select the desired channel (1 to 9) to register the DTMF code, then press the **FUNC** knob.
The DTMF memory channel input screen is displayed.
3. Use the **FUNC** knob or the numeric keypad of the microphone to input the DTMF code up to a maximum of 16 digits.
4. Press and hold the **FUNC** knob to save the DTMF code.
5. Press the **DIAL** knob, **SUB DIAL** knob or **PTT** switch to finish the setting and return to the original screen.

Setting the auto dialer function

Use the auto dialer function to automatically transmit the DTMF code registered in the DTMF memory.

1. Press and hold the **FUNC** knob → [12 AUTO DIALER] → Press the **FUNC** knob
2. Rotate the **FUNC** knob to select "ON".
3. Press the **DIAL** knob, **SUB DIAL** knob or **PTT** switch to finish the setting and return to the original screen.

When set to "ON", the DTMF icon "☎" will be shown on the display.

Transmitting DTMF code automatically using DTMF memory

1. Set the "ON" by referring to "Transmitting the Registered DTMF Code" (above).
2. Press the **FUNC** key → [DTMF] → Press the **FUNC** knob
3. Rotate the **FUNC** knob to select the desired DTMF memory (1 to 9).
4. Press the **PTT** switch.
 - The DTMF code registered in the DTMF memory channel is automatically transmitted.
 - Even after releasing the **PTT** switch, the transmission continues until the DTMF code is completed. The transceiver is automatically returned to receive mode.
 - To send DTMF memory, press the number key of that number on the microphone during transmission.

Manually Transmitting the DTMF Code

1. While pressing and holding the **PTT** switch, use the numeric keypad of the microphone and press each digit of the DTMF code in sequence to transmit the code.



The DTMF code can be sent manually regardless of whether the auto dialer is set to ON or OFF.

Using the GPS Function

The transceiver is equipped with an internal GPS receiver to acquire and display the position information. The GPS information can be used as described in the following examples:

Display the location information of the partner station in digital mode

→ Refer to “Real-Time Navigation Function” (Page 18)

Save the position information in the memory and use it for navigation purposes

→ Refer to “Backtrack Function” (Page 18)

Save this station location information and display the route on a computer

→ Refer to “Saving GPS Information (GPS Log Function)” (Page 20)

Save the DP-ID of frequently contacted stations and check whether they are within the sphere of communications

→ Refer to the separate “Operating Manual GM Edition”

Exchange position information and messages through data communications with other stations

→ Refer to the separate “Operating Manual APRS Edition”

Positioning Using GPS

The built-in GPS receiver function is enabled when the power of the **FTM-500DR/DE** is turned ON. The satellite search will begin and the “” icon will be shown at the top of the display. The **FTM-500DR/DE** automatically obtains the internal clock setting, and the location information setting from the GPS data.



- It may take several minutes to acquire the GPS satellites.
- When three or more satellites cannot be acquired, the “” icon will disappear. In this case, positioning is not possible, and the position information cannot be used.

About Positioning by GPS

“Positioning” refers to calculation of the current position from the satellite orbit information and radio propagation time. At least 3 satellites must be acquired for successful positioning. If positioning fails, move away from buildings as far as possible away buildings and position the GPS receiver in an area with open sky.

● About errors

The measurement environment may result in positioning errors of several hundred meters. Under favorable conditions, positioning can be performed successfully using only three satellites. However, under the following poor conditions, the positioning accuracy can decrease, or positioning can fail:

- Between tall buildings
- Narrow paths between buildings
- Indoors or near large buildings
- Between trees such as in forests or woods
- Under elevated roads or high voltage power lines
- Inside a tunnel or underground
- Through heat reflective glass
- Areas with strong magnetic fields

● When not in use for a long time

When using the GPS functions for the first time after purchase, or when it has been unused in a while, a few minutes may be required to acquire the satellites. Also, if the GPS function has been turned OFF for several hours, a few minutes may be required to search for satellites.

Smart Navigation Function

GPS position information and voice signals are simultaneously transmitted in the V/D mode of C4FM digital. Consequently, the position and direction of the remote station can be displayed in real time, even while communicating.

 To use the "latitude/longitude display" with the smart navigation function, press and hold the **FUNC** knob → [5 LOCATION INFO] and set to "NUMERIC". (The factory setting is "COMPASS")

Real-Time Navigation Function

1. Press and hold the **FUNC** knob → [7 DISPLAY MODE] → Press the **FUNC** knob.
2. Rotate the **FUNC** knob to select [BACKTRACK] then press the **FUNC** knob.
The distance and direction to the remote station operating on the same frequency in the V/D mode are displayed.

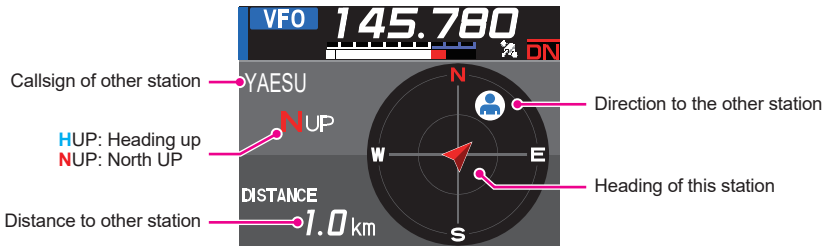

 On the real-time navigation screen, press the PTT switch to communicate with the partner station by voice as usual. You can be also change the communication mode and frequency, and recall memory channels.

Backtrack Function

By registering a navigation point in advance (such as the departure point), the distance and direction to the registered point from the current position can be displayed in real time.

● Registering the Current Position (Departure Point)

1. In the Real-Time Navigation screen, press the **SUB DIAL** knob.
2. Rotate the **SUB DIAL** knob to select [MEM] then press the **SUB DIAL** knob.
 - "★", "L1" and "L2" blink.
 - Without the latitude and longitude information, the location cannot be registered.

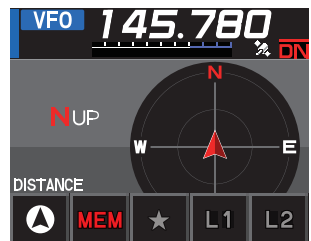

3. Rotate the **SUB DIAL** knob to select the mark ([★], [L1] or [L2]) to register the position information.
4. Press the **SUB DIAL** knob.
The location information is registered with the selected mark and navigation starts.
5. Press the [BACK] key return to normal operation display.

● Using the Back Track Function

1. In the Real-Time Navigation screen, press the **SUB DIAL** knob.
2. Rotate the **SUB DIAL** knob to select the mark ([★], [L1] or [L2]) to register the location information for back tracking.

Marks for which location information has not been registered are displayed in gray.

3. Press the **SUB DIAL** knob.

- Navigation will start.
- The green point in the compass indicates the direction of the registration point (departure point), so by proceeding so that the green point is always on top, the registration point can be reached. (When the compass is in heading up display).

4. Press the **[BACK]** key to end the navigation and return to normal operation display.

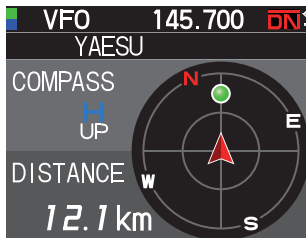

● Changing the direction of the compass panel

The compass panel can be set to “HEADING UP” where the direction of travel is always displayed at the top, or “NORTH UP” where North is always displayed at the top.

1. Press and hold the **FUNC** knob → **[6 COMPASS]** → Press the **FUNC** knob
2. Rotate the **FUNC** knob to select **[HEADING UP]** or **[NORTH UP]**.
3. Press the **DIAL** knob, **SUB DIAL** knob or **PTT** switch to finish the setting and return to the original screen.

Saving GPS Information (GPS Log Function)

The GPS position information can automatically be saved periodically onto a microSD memory card. Using the saved data, tracks can be displayed on a computer with commercially available map software*.

* Technical support for the map software is not provided by YAESU.

1. Press and hold the **FUNC** knob → **[39 GPS LOG]** → Press the **FUNC** knob
2. Rotate the **FUNC** knob to select the GPS data logging interval.
OFF / 1 sec / 2 sec / 5 sec / 10 sec / 30 sec / 60 sec
3. Press the **DIAL** knob, **SUB DIAL** knob or **PTT** switch to finish the setting and return to the original screen.

The GPS log function is activated, and GPS log “**LOG**” icon will be displayed.

- The position information is saved periodically unless “OFF” is selected in step 2 (shown above) or the power of the transceiver is turned OFF.
 - Reselecting the GPS data logging interval in step 2 or turning on the transceiver again, begins saving the GPS data under a different file name.
 - To use the GPS log function, a commercially available micro SD card must be inserted in the **FTM-500DR/DE**. Refer to the Operating Manual for details.
-



Checking Tracks on Your PC

1. Turn the transceiver OFF.
 2. Remove the microSD memory card from the transceiver.
 3. Connect the microSD memory card to a PC using a commercially available memory card reader.
 4. Open the “FTM500D” folder in the microSD memory card.
 5. Open the “GPSLOG” folder.
 - The data is saved as “yymmddhhmmss.log”
 - The [yymmddhhmmss] part of the name consists of year (yy), month (mm), day (dd), hour (hh), minute (mm), and second (ss).
-



- Tracks can be displayed on the map by importing the data to commercially available map software.
 - For information on importing, please refer to the operation manual for the map software you use.
-

GPS Screen Information and Operation

Activating the GPS function presents the following information on the display.

1. Press and hold the **FUNC** knob → [7 DISPLAY MODE] → Press the **FUNC** knob
2. Rotate the **FUNC** knob to select [GPS INFORMATION] then press the **FUNC** knob.

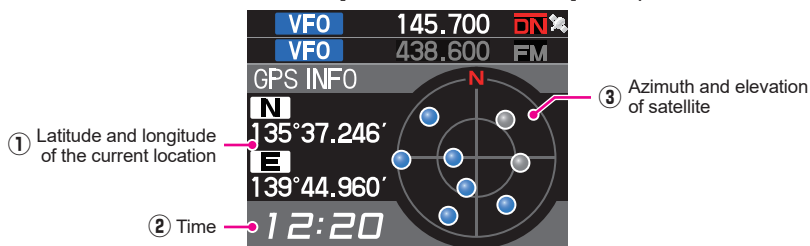

- ① Displays the latitude and longitude

Latitude (upper side)

Display format: X DD°MM.MMM'

X: X=N: North latitude, X=S: South latitude, DD: Degree, MM:MMM Minute

Example: N 35°38.250 (35 degrees, 38 minutes, 15 seconds north latitude)

Longitude (lower side)

Display format: X DDD°MM.MMM'

X: X=E: East longitude, X=W: West longitude, DDD: Degree, MM:MMM Minute

Example: E 139°42.500 (139 degrees, 42 minutes, 30 seconds east longitude)

- ② Current time (24-hour display)
- ③ Displays the satellite azimuth and elevation angles. Displays in North-up mode. Receiving satellites are displayed in blue.

- When the GPS function is used, the accurate time and date are obtained from GPS and shown on the LCD in 24-hour format. This time data is displayed on the GPS and APRS screens.
- The geodetic system datum (WGS-84 / TOKYO MEAN) of the built-in GPS unit may be changed by pressing and holding the **FUNC** knob → [37 GPS DATUM] in Set mode. However, since APRS uses the WGS-84 geodetic system, it is recommended not to change it.
- The time zone may be set at 30-minute increments by pressing and holding the **FUNC** knob → [32 TIME ZONE] (the default setting: UTC 0:00).
- The position information obtained from an externally connected GPS device may be used by pressing and holding the **FUNC** knob → [38 GPS DEVICE] and then setting "EXTERNAL". In this case, the data from the internal GPS will be ignored.
- When using an external GPS device, move it away from the transceiver to reduce interference.



Measuring the altitude

The changes in the altitude of the current position and the distance traveled can be displayed on a graph.

1. Press and hold the **FUNC** knob → [7 DISPLAY MODE]
→ Press the **FUNC** knob
2. Rotate the **FUNC** knob to select [ALTIITUDE] then press the **FUNC** knob.
The altitude screen is displayed.

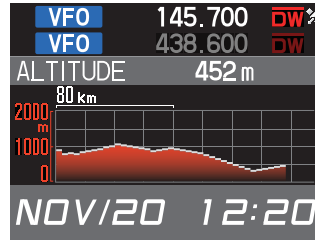

● Changing the altitude scale

1. In the Altitude scale screen, press the **SUB DIAL** knob.
2. Rotate the **SUB DIAL** knob to select [SCALE].
3. Press the **SUB DIAL** knob, the scale value will change in the following order.
5mi (5km) / 20mi (20km) / 40mi (40km) / 80mi (80km)



The maximum altitude scale will be automatically set based on the present altitude values.

● Erasing the previous altitude changes

1. In the Altitude scale screen, press the **SUB DIAL** knob.
2. Rotate the **SUB DIAL** knob to select [CLEAR] then press the **SUB DIAL** knob.
The graph (history) is deleted.

Functions used as needed

Timer / Clock function

1. Press and hold the **FUNC** knob → [7 DISPLAY MODE] → Press the **FUNC** knob
2. Rotate the **FUNC** knob to select [TIMER/CLOCK] then press the **FUNC** knob.
The Clock screen will be displayed.
3. Press the **SUB DIAL** knob.
4. The following functions can be selected each time the **SUB DIAL** knob is pressed.
Clock screen / Lap timer screen / Countdown timer screen
5. Press the [BACK] key twice to return to the original screen.

Using the lap timer

1. In the Timer / Clock function screen, press the **SUB DIAL** knob.
2. Press the **SUB DIAL** knob several times to display the Lap timer screen.

● Start measurement

1. Rotate the **SUB DIAL** knob to select [START] then press the **SUB DIAL** knob.
The timer will start.

VFO	145.700	DN
VFO	438.600	DN
TIMER		
PREVIOUS LAP-01	22:22'22"	
CURRENT	22:22'22"	
MODE	START	RESET
		RECALL

● Measure lap time

1. Rotate the **SUB DIAL** knob during measurement and select [LAP].
2. Each time the **SUB DIAL** knob is pressed, the lap time is stored.
Up to 99 lap times can be saved in the memory.

VFO	145.700	DN
VFO	438.600	DN
TIMER		
PREVIOUS LAP-01	22:22'22"	
CURRENT	22:22'22"	
MODE	STOP	LAP
		RECALL

● Call lap time

1. Rotate the **SUB DIAL** knob to select [RECALL] then press the **SUB DIAL** knob.
The lap time and split time are displayed.
2. When there are multiple lap times, rotate the **SUB DIAL** knob to select [▲] or [▼] then press the **SUB DIAL** knob to switch between the lap times.

● Stop measurement

1. Rotate the **SUB DIAL** knob to select [STOP] then press the **SUB DIAL** knob.
The timer will stop.

● Clear the measurement result

1. When measurement is stopped, turn the **SUB DIAL** knob to select [RESET] then press the **SUB DIAL** knob.
All measurement results will be erased.

Using the countdown timer

1. In the Timer/Clock function screen, press the **SUB DIAL** knob.
2. Rotate the **SUB DIAL** knob to select **[MODE]** then press the **SUB DIAL** knob several times to display the count down timer screen.

● Set the timer

1. Rotate the **SUB DIAL** knob to select **[SETUP]** then press the **SUB DIAL** knob.
The countdown timer setting screen will be displayed.
The factory default is 15 minutes.

2. Rotate the **SUB DIAL** knob to select [-] or [+] then press the **SUB DIAL** knob to set the hour.
The hour can be set between 00 and 99.
3. Rotate the **SUB DIAL** knob to select **[SETUP]** then press the **SUB DIAL** knob.
4. Rotate the **SUB DIAL** knob to select [-] or [+] then press the **SUB DIAL** knob to set the minute.
The minute can be set between 00 and 59.
5. Rotate the **SUB DIAL** knob to select **[SETUP]** then press the **SUB DIAL** knob.

● Start the timer

1. Rotate the **SUB DIAL** knob to select **[START]** then press the **SUB DIAL** knob.
 - The countdown timer will start.
 - When the set time has elapsed, a beep will sound.

● Stop the timer

1. Rotate the **SUB DIAL** knob to select **[STOP]** then press the **SUB DIAL** knob.
 - To restart, rotate the **SUB DIAL** knob to select **[START]** then press the **SUB DIAL** knob.
 - To reset the timer to the set value, turn the **SUB DIAL** knob to select **[RESET]** then press the **SUB DIAL** knob.



Using the Voice Guide unit FVS-2

The receive audio can be recorded and then played back later using the optional voice guide unit “FVS-2”. The frequency of the operating band can also be announced by voice when the announce function is set to ON.

Mounting the voice guide unit “FVS-2”

● Preparations

- Voice guide unit “FVS-2” (optional)
- Phillips screwdriver

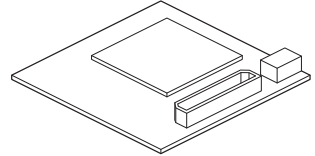

● Mounting procedure



- Avoid touching the electronic components with your hands as the semiconductors may be damaged by static electricity.
- Note that labor charges to install optional items by our customer service support staff shall be separately chargeable.

1. Turn the transceiver OFF.
2. Turn the external power supply OFF.
3. Unplug the control cable, microphone, and DC power supply cables from the main chassis.
4. Remove the eight screws from the main body, four on top and two each at the sides.



※: Please note that the 2 screws on the front panel side of the top cover are longer than the other 6 screws.

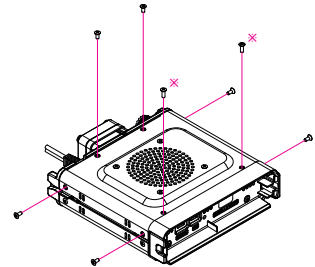

5. Carefully lift the top cover of the main body.



Do not lift the top cover by force. This may result in cables connected between the circuit boards and the speaker inside the cover to be cut.

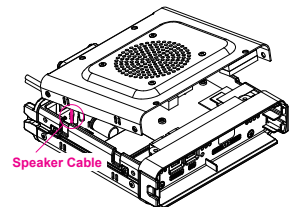

6. Unplug the speaker cables extending from the top cover from the socket on the board inside the main body before removing the cover.



Hold the connector when unplugging the cable without pulling on the cable itself.

7. Refer to the figure on the right to mount the FVS-2.



Check the direction of the connector and plug the FVS-2 in all the way to the back.

8. Plug in the speaker cables extending from the main body top cover to the original connector on the board.
9. Attach the main body top cover and secure it using the eight screws.

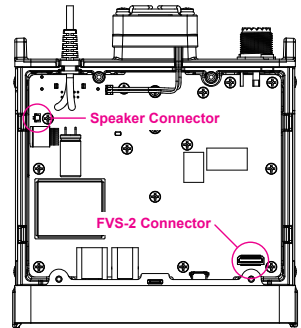
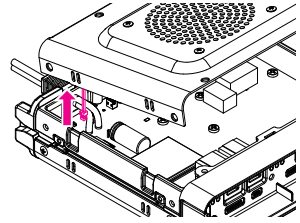

Using the voice memory

The voice memory permits recording the received audio in the optional FVS-2 that is mounted inside the radio. The saved audio can be replayed on the radio and erased later.

Setting the voice memory operation

1. Press and hold the **FUNC** knob → [**112 VOICE MEMORY**] → Press the **FUNC** knob
 - The screen for the detailed settings will be displayed.
 - Cannot be selected when the optional FVS-2 is not installed.
2. Rotate the **FUNC** knob to select [**PLAY/REC**].
3. Rotate the **FUNC** knob, the recording operation switches.

FREE 5min: A total of 5 minutes of audio in 8 recording areas can be recorded.

LAST 30sec: The last 30 seconds will be recorded.

Factory default value: **FREE 5min**

4. Press the **DIAL** knob, **SUB DIAL** knob or **PTT** switch to finish the setting and return to the original screen.

Recording the receive audio

1. Press and hold the **FUNC** knob → [113 FVS REC] → Press the **FUNC** knob
The recording will be started.
2. Rotate the **FUNC** knob to select [116 FVS STOP], then press the **FUNC** knob.
The recording will stop.
3. Press the **DIAL** knob, **SUB DIAL** knob or **PTT** switch to finish the setting and return to the original screen.

Replaying the recorded audio

1. Press and hold the **FUNC** knob → [115 FVS PLAY] → Press the **FUNC** knob
 - Replay will be started.
 - Replay will stop automatically at the end of the selected track.
2. Rotate the **FUNC** knob to select [116 FVS STOP], then press the **FUNC** knob.
The replay will stop.
3. Press the **DIAL** knob, **SUB DIAL** knob or **PTT** switch to finish the setting and return to the original screen.

Selecting the track

1. Press and hold the **FUNC** knob → [114 TRACK SELECT] → Press the **FUNC** knob
2. Rotate the **FUNC** knob to select the track number to be replayed.
“ALL”, “1”, “2”... , “8”
 - When “ALL” is selected, all the recorded tracks will be replayed in sequence.
3. Press the **FUNC** knob.

Erasing the recorded audio

1. Press and hold the **FUNC** knob → [117 FVS CLEAR] → Press the **FUNC** knob
The confirmation screen will be displayed.
2. Rotate the **FUNC** knob to select [OK], then press the **FUNC** knob.
A beep will sound, and erasing will be started.



All recorded audio will be erased. When there are two or more recordings, individual tracks cannot be erased.

3. Press the **DIAL** knob, **SUB DIAL** knob or **PTT** switch to finish the setting and return to the original screen.

Voice announcement of the operating frequency

Setting the announce function operation

Set the following voice announcement parameters:

- Automatically announce the frequency or not
- Announce out the frequency in English or Japanese
- Voice announcement audio level
- Mute the receive audio during a voice announcement.

1. Press and hold the **FUNC** knob → [**112 VOICE MEMORY**] → Press the **FUNC** knob
Cannot be selected when the optional FVS-2 is not installed.
2. Rotate the **FUNC** knob to select [**ANNOUNCE**] then press the **FUNC** knob.
3. Rotate the **FUNC** knob to select the condition for reading out of the frequency.
OFF: The frequency is not announced.
AUTO: The frequency is announced when changing bands, or when switching between VFO mode and Memory mode.
MANUAL: To announce: **FUNC** knob → [**118 VOICE GUIDE**] → Press the **FUNC** knob

Factory default value: AUTO

4. Press the **FUNC** knob.
5. Rotate the **FUNC** knob to select [**LANGUAGE**] then press the **FUNC** knob.
6. Rotate the **FUNC** knob to select the language in which the frequency is announced.
ENGLISH / JAPANESE

Factory default value: ENGLISH

7. Press the **FUNC** knob.
8. Rotate the **FUNC** knob to select [**VOLUME**] then press the **FUNC** knob.
9. Rotate the **FUNC** knob to select the announcement volume.

HIGH / MID / LOW

Factory default value: HIGH



The volume of the announcement voice is linked to the volume of the operation band.

10. Press the **FUNC** knob.
11. Rotate the **FUNC** knob to select [**RX MUTE**] then press the **FUNC** knob.
12. Rotate the **FUNC** knob to select ON/OFF.
ON: The receive audio will be muted during a voice announcement or replaying recorded audio.
OFF: The receive audio will not be muted during a voice announcement or replaying recorded audio.
Factory default value: ON
13. Press the **DIAL** knob, **SUB DIAL** knob or **PTT** switch to finish the setting and return to the original screen.

Voice announcement of the operating frequency

(1) When the voice announcement is set to “AUTO”

The frequency of the operating band will be automatically announced in the following cases:

- When the VFO mode and memory mode are switched.
- When the operating band is changed.

(2) When the voice announcement is set to “MANUAL”

1. Press and hold the **FUNC** knob → [**118 VOICE GUIDE**] → Press the **FUNC** knob.
The frequency of the operating band will be announced.

Copying the Radio Data to another Transceiver

The memory channels and settings in the set-up menu can be copied to another **FTM-500DR/DE**. This is convenient when matching the settings of fellow stations that you communicate with frequently.

1. Turn both transceivers OFF.
2. Connect the clone cable “CT-166” to the DATA jack on the back of the main bodies.
3. Turn both transceivers ON.
4. On the transceiver from which data is to be copied, press and hold the **FUNC** knob, rotate the **FUNC** knob to select [**119 This → Other**], then press the **FUNC** knob. The confirmation screen appears.
5. On the transceiver to which data is to be copied, press and hold the **FUNC** knob, rotate the **FUNC** knob to select [**120 Other → This**], then press the **FUNC** knob. The confirmation screen appears.
6. On the transceiver to which data is to be copied, rotate the **FUNC** knob to select [**OK**], then press the **FUNC** knob.
7. On the transceiver from which data is to be copied, rotate the **FUNC** knob to select [**OK**], then press the **FUNC** knob. The data transfer begins.
8. Turn both transceivers OFF, then disconnect the clone cable.



-
- When “ERROR” appears on the screen during the clone operation, the operation has not completed. Check the clone cable connection, and then repeat the procedure from the beginning.
 - If the clone operation is terminated due to a power loss during the data transfer, the transceiver to which the data is copied will be reset automatically. Check the power supply, cables and connections, then repeat the procedure again from the beginning.
-

Connecting an external device

Using the Data cable, the transceiver can be connected to a personal computer as a COM port for the following operations:

- Transfer GPS location data and export route mapping information to computer software
- Packet communication

Use the DATA jack at the back of the main body to connect with the personal computer. The pin assignment of the DATA jack is as follows.

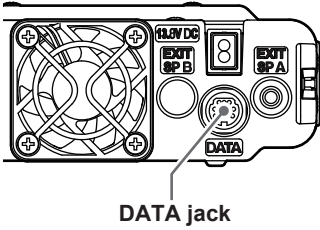

DATA jack



- ① PKD (packet data input)
- ② GND
- ③ PKS (PTT)
- ④ RX 9600 (9600 bps packet data output)
- ⑤ RX 1200 (1200 bps packet data output)
- ⑥ PK SQL (squellch control)
- ⑦ TXD (serial data output [transceiver → PC])
- ⑧ RXD (serial data input [transceiver ← PC])
- ⑨ CTS (data communication control)
- ⑩ RTS (data communication control)

Connecting to a computer

● Preparation

- Computer
- PC connection cable "SCU-20" (Included in optional SCU-40)...(When connecting to the USB jack of the computer.)

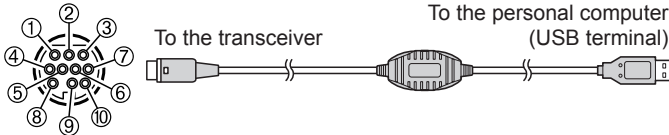

- Make sure to turn the transceiver OFF before connecting any cables.
- When using the SCU-20 PC connection cable, install the designated driver on the computer. Download the driver and installation manual from the Yaesu website.

Transmitting GPS location information

The GPS position data (latitude/longitude) of this station can be output from the serial DATA jack on the rear of the transceiver.

1. Press and hold the **FUNC** knob → [**69 COM PORT**] → Press the **FUNC** knob.
2. Rotate the **FUNC** knob to select [**SPEED**] then press the **FUNC** knob.
3. Rotate the **FUNC** knob to select the desired communication speed then press the **FUNC** knob.

The setting changes in the following order:

4800bps → 9600bps → 19200bps → 38400bps → 57600bps

Factory default value: 9600bps

4. Press the **FUNC** knob.
5. Rotate the **FUNC** knob to select [**OUTPUT**] then press the **FUNC** knob.
6. Rotate the **FUNC** knob to select "**GPS OUT**" then press the **FUNC** knob.

The setting changes in the following order:

OFF → GPS OUT → PACKET → WAYPOINT

Factory default value: OFF

7. Press the **DIAL** knob, **SUB DIAL** knob or **PTT** switch to finish the setting and return to the original screen.

Transmits the location information data. The location data is output to the computer at about one second intervals.



An operating software using NMEA-0183 standard GGA and RMC sentence is required to use the position information.

Using the transceiver for packet communications

A TNC (Terminal Node Controller) may be connected to the transceiver to enable packet communications.

● Preparation

- TNC
- Computer
- Data cable* ... Prepare a cable suitable for the connected device.

*The following optional products are available.

- Data cable "CT-164"

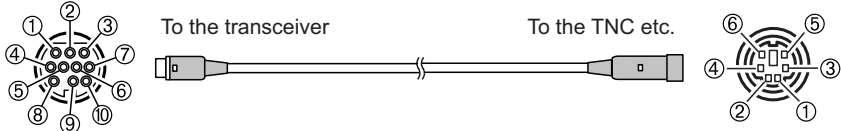

- ① PKD (packet data input)
- ② GND
- ③ PKS(PTT)
- ④ RX 9600 (9600 bps packet data output)
- ⑤ RX 1200 (1200 bps packet data output)
- ⑥ PK SQL (squelch control)
- ⑦ -
- ⑧ -
- ⑨ -
- ⑩ -

- ① PKD (packet data input)
- ② GND
- ③ PKS(PTT)
- ④ RX 9600 (9600 bps packet data output)
- ⑤ RX 1200 (1200 bps packet data output)
- ⑥ PK SQL (squelch control)

- Data cable "CT-163"

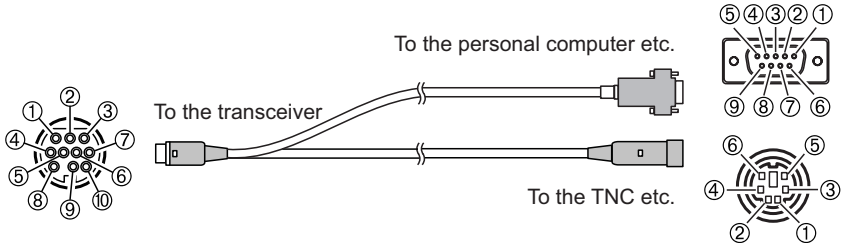

- ① PKD (packet data input)
- ② GND
- ③ PKS(PTT)
- ④ RX 9600 (9600 bps packet data output)
- ⑤ RX 1200 (1200 bps packet data output)
- ⑥ PK SQL (squelch control)
- ⑦ TXD (serial data output [transceiver → PC])
- ⑧ RXD (serial data input [transceiver ← PC])
- ⑨ CTS (data communication control)
- ⑩ RTS (data communication control)

Dsub 9 pin

- ① -
- ② TXD (serial data output [transceiver → PC])
- ③ RXD (serial data input [transceiver ← PC])
- ④ -
- ⑤ GND
- ⑥ -
- ⑦ CTS (data communication control)
- ⑧ RTS (data communication control)
- ⑨ -

DIN 6 pin

- ① PKD (packet data input)
- ② GND
- ③ PKS(PTT)
- ④ RX 9600 (9600 bps packet data output)
- ⑤ RX 1200 (1200 bps packet data output)
- ⑥ PK SQL (squelch control)

- Data cable “CT-167” (optional)

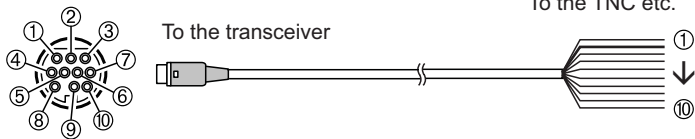

① PKD (packet data input)	① Brown PKD (packet data input)
② GND	② Black thick wire GND
③ PKS(PTT)	③ Red PKS (PTT)
④ RX 9600 (9600 bps packet data output)	④ Orange RX 9600 (9600 bps packet data output)
⑤ RX 1200 (1200 bps packet data output)	⑤ Yellow RX 1200 (1200 bps packet data output)
⑥ PK SQL (squelch control)	⑥ Green PK SQL (squelch control)
⑦ TXD (serial data output [transceiver → PC])	⑦ Blue TXD (serial data output [transceiver → PC])
⑧ RXD (serial data input [transceiver ← PC])	⑧ Grey RXD (serial data input [transceiver ← PC])
⑨ CTS (data communication control)	⑨ White CTS (data communication control)
⑩ RTS (data communication control)	⑩ Black RTS (data communication control)



- Make sure to turn the power to the radio OFF before connecting.
- Refer to the TNC operating manual for instruction on connecting the TNC to a personal computer.
- RF receive interference may occur because of noise occurring in the personal computer. When signals cannot be received normally, keep the personal computer at a distance away from the radio and use a photo-coupler and noise filter to connect.

● Packet communication settings

1. Press and hold the **FUNC** knob → [**69 COM PORT**] → Press the **FUNC** knob
2. Rotate the **FUNC** knob to select [**SPEED**] then press the **FUNC** knob.
3. Rotate the **FUNC** knob to select the desired communication speed then press the **FUNC** knob.

The setting changes in the following order:

4800bps → 9600bps → 19200bps → 38400bps → 57600bps

Factory default value: 9600bps

4. Press the **FUNC** knob.
5. Rotate the **FUNC** knob to select [**OUTPUT**] then press the **FUNC** knob.
6. Rotate the **FUNC** knob to select [**PACKET**] then press the **FUNC** knob.

The setting changes in the following order:

OFF → GPS OUT → PACKET → WAYPOINT

Factory default value: OFF

7. Press the [**BACK**] key twice.
8. Rotate the **FUNC** knob to select [**70 DATA BAND**] then press the **FUNC** knob.
9. Rotate the **FUNC** knob to select [**DATA**], then press the **FUNC** knob.
10. Rotate the **FUNC** knob to select the band to be used for the packet communication then press the **FUNC** knob.

The setting changes in the following order:

MAIN BAND → SUB BAND → THIS BAND → OTHER BAND → ...

- Refer to “**70 DATA BAND**” (page 63) for details.

11. Press the [**BACK**] key twice.

12. Rotate the **FUNC** knob to select [**71 DATA SPEED**] then press the **FUNC** knob.
13. Rotate the **FUNC** knob to select [**DATA**] then press the **FUNC** knob.
14. Rotate the **FUNC** knob to select the packet communication speed.
The setting will switch between “1200 bps” and “9600 bps” then press the **FUNC** knob.
Factory default value: 1200bps
15. Press the [**BACK**] key twice.
16. Rotate the **FUNC** knob to select [**72 DATA SQL**] then press the **FUNC** knob.
17. Rotate the **FUNC** knob to select [**DATA**] then press the **FUNC** knob.
18. Rotate the **FUNC** knob to select the squelch detection method for the packet communication.
The setting switches between “RX BAND” and “TX/RX BAND”.
 - Refer to “**72 DATA SQL**” (page 65) for details.
 - Factory default value: RX BAND
19. Press the [**BACK**] key.
20. Rotate the **FUNC** knob to select [**TX**] then press the **FUNC** knob.
21. Rotate the **FUNC** knob to select the squelch detection method for the packet communication.
The setting switches between “ON” and “OFF”.
 - Refer to “**72 DATA SQL**” (page 65) for details.
 - Factory default value: ON
22. Press the **DIAL** knob, **SUB DIAL** knob or **PTT** switch to finish the setting and return to the original screen.

This completes the packet communication settings.

When transmitting a large volume of packet data, the transmission time gets longer, and the transceiver may heat up. When transmission continues for a long period of time, the overheating prevention circuit will act to lower the transmit power output. When transmission is continued further, transmission will be suspended automatically, and the transceiver will go into the receive mode to prevent failure due to overheating. When the overheating prevention circuit is activated and the radio goes into the receive mode, either switch the power OFF, or wait in receive mode until the transceiver cools.



Updating the transceiver firmware

When updated firmware is available, the transceiver can be updated by connecting it to a personal computer. Download the latest version of the firmware and the firmware installation manual from the YAESU website.

Setup Menu

The Set Mode permits configuring the various functions to accommodate individual operating needs and preferences.

Setup Menu Operation

1. Press and hold the **FUNC** knob.

The SETUP MENU screen will be displayed.



- Press and hold the **FUNC** knob on the setup menu screen to register the selected setup menu item to the CFL (Custom Function Menu). Refer to the Operating Manual for details.
- Items registered in the custom function menu can also be called from the function menu.

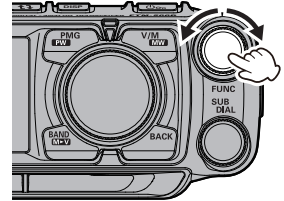

2. Touch the desired item in the Setup Menu.

Or rotate the **FUNC** knob to select the desired item in the Setup Menu, then press the **FUNC** knob.

- “>” is displayed at the right of submenu items that have a deeper level of menu items.
- Press the [**BACK**] key to return to the previous screen.
- Rotate the **SUB DIAL** knob, or press the [**UP**] / [**DWN**] key on the microphone to scroll through the 17 categories in the Setup Menu (See below):

DISPLAY ↔ **TX** ↔ **RX** ↔ **MEMORY** ↔ **CONFIG** ↔
↔ **AUDIO** ↔ **SIGNALING** ↔ **SCAN** ↔ **DIGITAL** ↔
↔ **GM** ↔ **WIRES-X** ↔ **DATA** ↔ **APRS** ↔
↔ **SD CARD** ↔ **OPTION** ↔ **CLONE** ↔ **RESET**

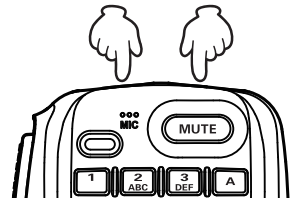
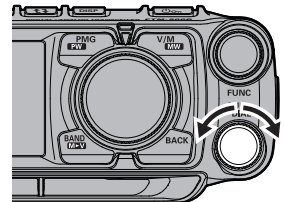
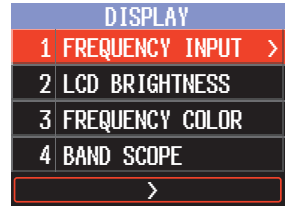

3. When there is no deeper level of menu items, go to step 4.

When there is a deeper level of menu items, rotate the **FUNC** knob to select the desired item, then press the **FUNC** knob.

4. Rotate the **FUNC** knob to change the setting value.
5. Press the **DIAL** knob, **SUB DIAL** knob or **PTT** switch to finish the setting and return to the original screen.

Tables of Setup Menu Operations

Menu Number / Item	Description	Selectable options (Options in bold are the default settings)
--------------------	-------------	--

DISPLAY

1 FREQUENCY INPUT	Enter frequency directly or display memory channel list.	-
2 LCD BRIGHTNESS	Display and key button brightness.	MIN / MID / MAX
3 FREQUENCY COLOR	Set the font color of the operation band frequency.	WHITE / BLUE / RED
4 BAND SCOPE	Scope Display width setting.	NARROW / WIDE
5 LOCATION INFO	Switch between the compass screen and the latitude/longitude display screen when using the GPS and GM functions.	COMPASS / NUMERIC
6 COMPASS	Set the compass display of the smart navigation function.	NORTH UP / HEADING UP
7 DISPLAY MODE	Back Track, Altitude, Timer/Clock or GPS Information screen display.	BACKTRACK / ALTITUDE / TIMER/CLOCK / GPS INFORMATION

TX

8 TX POWER	Set the transmit power level.	LOW / MID / HIGH
9 AMS TX MODE	Set the AMS transmission mode.	AUTO / TX FM FIXED/ TX DN FIXED
10 MIC GAIN	Microphone sensitivity setting.	MIN / LOW / NORMAL / HIGH / MAX
11 VOX	VOX function settings.	VOX: OFF / LOW / HIGH DELAY: 0.5s / 1.0s / 1.5s / 2.0s / 2.5s / 3.0s VOX MIC: FRONT / REAR
12 AUTO DIALER	DTMF code automatic transmit setting.	ON / OFF
13 TOT	TX time out setting.	OFF / 1min / 2min / 3min / 5min / 10min / 15min / 20min / 30min
14 DIGITAL VW	Turn the VW mode selection ON or OFF.	ON / OFF

RX

15 FM BANDWIDTH	Set the FM transmit modulation level.	WIDE / NARROW
16 RX MODE	Select the receive mode.	AUTO / FM / AM
17 SUB BAND		
SUB BAND	sub-band ON/OFF (lower screen display).	OFF / ON
SUBBAND MUTE	Sub-band mute setting	OFF / ON
18 AUDIO EQUALIZER		
FRONT TONE	Adjust the sound quality of the Control head speaker	OFF / FLAT / HI PITCH / LO PITCH / BPF
REAR TONE	Adjust the sound quality of the Main body speaker	FLAT / HI PITCH / LO PITCH / BPF / 1kHz LPF / 700Hz LPF
REAR OUT	Output level of the main body speaker	0% to 100%
AESS PHASE	Sets the time delay between the audio output of the control head speaker and the main unit speaker.	OFF / 1.25ms to 20.00ms (10.00ms)

MEMORY

19 HOME CH	Recall the home channel.	-
20 MEMORY LIST	Displays the Memory channel list screen.	-

Menu Number / Item	Description	Selectable options (Options in bold are the default settings)
21 MEMORY LIST MODE	Displays a list of memory channels in memory mode.	ON / OFF
22 PMG		
PMG TIMER	Scan resume time after there is no signal when receiving in PMG mode simultaneously.	1sec / 2sec / 3sec
PMG CLEAR	Cancel the registration of all PMG channels.	-
CONFIG		
23 BEEP	Beep volume setting.	OFF / LOW / HIGH
24 BAND SKIP	Set the frequency bands that can be selected.	AIR: ON / OFF VHF: ON / OFF UHF: ON / OFF OTHER: ON / OFF
25 RPT ARS	Repeater auto shift setting.	OFF / AUTO
26 RPT SHIFT	Repeater shift direction setting.	AUTO / - / +
27 RPT SHIFT FREQ	Repeater TX offset setting.	0.00MHz to 99.95MHz
28 RPT REVERSE	Reverses the transmit and receive frequencies while working through a repeater.	NORMAL / REVERSE
29 MIC PROGRAM KEY	Microphone P1 / P2 / P3 / P4 buttons programmable settings.	OFF / 2nd PTT / GM / REC/STOP / SCAN / HOME CH / RPT SHIFT / REVERSE / TX POWER / SQL OFF / T-CALL / VOICE* / D_X / WX / STN LIST / MSG LIST / REPLY / MSG EDIT / DW (*requires optional FVS-2) P1: 2nd PTT P2: HOME CH P3: D_X P4: WX (T-CALL: European version)
30 DATE&TIME ADJUST	Set the date and time.	-
31 DATE&TIME FORMAT	Set the date and time display formats.	Date: mmm/dd/yyyy / yyyy/mmm/dd / dd/mmm/yyyy / yyyy/dd/mmm Time: 24hour / 12hour
32 TIME ZONE	Time zone setting.	UTC -14:00 to ±0:00 to +14:00
33 STEP	Frequency tuning step.	AUTO / 5.00 kHz / 6.25 kHz / (8.33 kHz) / 10.00 kHz / 12.50 kHz / 15.00kHz / 20.00kHz / 25.00 kHz / 50.00 kHz / 100 kHz
34 CLOCK TYPE	Clock shift setting.	A / B
35 UNIT	Display unit setting.	METRIC / INCH (Depends on the transceiver version)
36 APO	Automatic power OFF time setting.	OFF / 0.5hour to 2.0hour (0.5 hour steps) / 2.0hour to 12.0hour (1.0 hour steps)
37 GPS DATUM	GPS function positioning selection.	WGS-84 / TOKYO MEAN
38 GPS DEVICE	GPS receiver selection.	INTERNAL / EXTERNAL
39 GPS LOG	GPS access time setting.	OFF / 1sec / 2sec / 5sec / 10sec / 30sec / 60sec

Menu Number / Item	Description	Selectable options (Options in bold are the default settings)
--------------------	-------------	--

AUDIO

40 RECORDING	Voice record function settings.	BAND: MAIN / SUB / MAIN+SUB MIC: ON / OFF
41 REC/STOP	Start and stop recording.	—
42 FRONT SP MUTE	Front speaker operation settings when external speakers are connected.	CONTINUE / AUTO MUTE

SIGNALING

43 DTMF	Load DTMF Autodialer Memories.	—
44 DTMF MEMORY	Set the DTMF auto dialer channel and code (16 characters).	1 to 9
45 SQL TYPE	Select a squelch type.	OFF / TONE ENC / TONE SQL / REV TONE / DCS / PR FREQ / PAGER / (DCS ENC) / (TONE DCS) / (DCS TSQL) *The options in the parentheses are available when the SQL expansion is ON.
46 TONE SQL FREQ or DCS CODE	Set the CTCSS Tone Frequency or the DCS code.	CTCSS: 67.0Hz to 254.1Hz (100Hz) DCS: 023 to 754
47 SQL EXPANSION	Separate squelch type setting for transmit and receive.	ON / OFF
48 PAGER CODE	Pager individual code settings.	RX-CODE 1: 01 - 05 - 50 RX-CODE 2: 01 - 47 - 50 TX-CODE 1: 01 - 05 - 50 TX-CODE 2: 01 - 47 - 50
49 PR FREQUENCY	User programmed reverse tone frequency.	300Hz - 1500Hz - 3000Hz
50 BELL RINGER	Recall sound length setting.	OFF / 1 time / 3 times / 5 times / 8 times / CONTINUOUS
51 WX ALERT	Weather alert operation setting.	ON / OFF

SCAN

52 SCAN	Engages the Scan operation.	-
53 DUAL RCV MODE	Dual receive operation setting.	OFF / PRIORITY SCAN
54 DUAL RX INTRVAL	Dual receive reception interval setting. (Only enabled when "53 DUAL RCV MODE" is set to "PRIORITY SCAN".)	0.5sec / 1.0sec / 2.0sec / 3.0sec / 5.0sec / 7.0sec / 10sec
55 PRIORITY REVERT	The transmission operation during dual receive always transmits on the home channel.	OFF / ON
56 SCAN RESUME	Set the resume operation after scanning stops on a signal.	BUSY / HOLD / 1sec / 3sec / 5sec

DIGITAL

57 DIGITAL POPUP	Information screen popup time.	OFF / 2sec / 4sec / 6sec / 8sec / 10sec / 20sec / 30sec / 60sec / CONTINUE
58 LOCATION SERVICE	Set whether to send your current location in digital mode.	ON / OFF
59 STANDBY BEEP	Standby Beep setting.	ON / OFF

Menu Number / Item	Description	Selectable options (Options in bold are the default settings)
--------------------	-------------	--

GM

* Refer to the separate Operating Manual GM Edition for details on the functions.

60 DP-ID LIST	Displays the DP-ID list screen.	–
61 RANGE RINGER	Set the bell sound when checking for stations within sphere of communications.	ON / OFF
62 RADIO ID	Specific transceiver ID is displayed.	– (cannot be edited)
63 LOG LIST	Display a list of recorded voices, received messages and images.	–

WIRES-X

* Refer to the separate Operating Manual WIRES-X Edition for details on the functions.

64 RPT/WIRES FREQ	Set the frequency to be used for Repeater / WIRES-X.	MANUAL / PRESET
FREQUENCY	Register the WIRES-X preset frequency.	Preset frequency: 146.550MHz 446.500MHz
65 SEARCH SETUP	Set the WIRES ROOM selection method.	HISTORY / ACTIVITY
66 EDIT CATEGORYTAG	Edit the category tag.	C1 to C5
67 DELETE ROOM/NODE	Delete a registered category.	C1 to C5
68 WIRES DG-ID	Set the DG-ID number for WIRES-X.	AUTO / 01 to 99

DATA

69 COM PORT	COM port settings	SPEED: 4800bps / 9600bps / 19200bps / 38400bps / 57600bps OUTPUT: OFF / GPS OUT / PACKET /WAYPOINT WP FORMAT: NMEA 6 / NMEA 7 /NMEA 8 / NMEA 9 WP FILTER: ALL / MOBILE / FREQUENCY / OBJECT/ITEM / DIGIPEATER / VoIP / WEATHER /YAESU / CALL RINGER / RANGE RINGER
70 DATA BAND	APRS/DATA band selection settings.	APRS: MAIN BAND / SUB BAND / THIS BAND / OTHER BAND DATA: MAIN BAND / SUB BAND / THIS BAND / OTHER BAND
71 DATA SPEED	APRS/DATA communication baud rate settings.	APRS: 1200 bps / 9600 bps DATA: 1200 bps / 9600 bps
72 DATA SQL	Squelch detection settings.	APRS: RX BAND / TX/RX BAND DATA: RX BAND / TX/RX BAND TX: ON / OFF

Menu Number / Item	Description	Selectable options (Options in bold are the default settings)
APRS		
* Refer to the separate Operation Manual APRS Edition for details on the functions.		
73 APRS DESTINATION	Model code display Non-editable.	APY500 (FIX)
74 APRS FILTER	Filter function settings.	Mic-E: ON / OFF POSITION: ON / OFF WEATHER: ON / OFF OBJECT: ON / OFF ITEM: ON / OFF STATUS: ON / OFF OTHER: ON / OFF RANGE LIMIT: OFF / 1 / 10 / 100 / 1000 / 3000 (km / mi) ALTNET: ON / OFF
75 APRS MSG TEXT	Standard message text input.	1 to 8 channels
76 APRS MODEM	Set APRS function ON/OFF.	OFF / ON
77 APRS MUTE	Set band B APRS audio mute.	OFF / ON
78 APRS POPUP	Beacons and messages Pop-up display time setting.	BEACON: OFF / 3sec / 5sec / 10sec / HOLD MESSAGE: OFF / 3sec / 5sec / 10sec / HOLD MYPACKET: OFF / ON
79 APRS RINGER	Set bell sound when beacons are received.	TX BEACON: ON / OFF TX MESSAGE: ON / OFF RX BEACON: ON / OFF RX MESSAGE: ON / OFF MY PACKET: ON / OFF CALL RINGER: ON / OFF RANGE RINGER: OFF / 1 / 5 / 10 / 50 / 100 (km / mi) MSG VOICE: ON / OFF
80 APRS RINGER (CS)	Call sign setting for CALL RINGER.	1 - 8 stations
81 APRS TX DELAY	Data transmit delay time setting.	100ms / 150ms / 200ms / 250ms / 300ms / 400ms / 500ms / 750ms / 1000ms
82 APRS UNITS	APRS display unit settings.	POSITION: dd°mm.mm' / dd°mm'ss" DISTANCE: km / mile * SPEED: km/h / mph / knot* ALTITUDE: m / ft * BARO: hPa / mb / mmHg / inHg* TEMP: °C / °F * RAIN: mm / inch * WIND: m/s / mph / knot* *(Depends on the transceiver version)
83 BEACON INFO	Transmit beacon information settings.	AMBIGUITY: OFF / 1 digit / 2 digits / 3 digits / 4 digits SPEED/COURSE: ON / OFF ALTITUDE: ON / OFF
84 BEACON STATUSTXT	Status text input settings.	SELECT: OFF / TEXT 1 - 5 TX RATE: 1/1 - 1/8 / 1/2(FREQ)- 1/8(FREQ) TEXT 1 - 5: NONE / FREQUENCY / FREQ & SQL & SHIFT

Menu Number / Item	Description	Selectable options (Options in bold are the default settings)
85 BEACON TX SET	Beacon automatic transmit / Manual transmit switch.	AUTO: OFF / ON / (SmartBeaconing)* INTERVAL: 30 sec - 5 min - 60 min PROPORTIONAL: ON / OFF DECAY: ON / OFF LOW SPEED: 1 - 3 - 99 (km / mph / knot) RATE LIMIT: 5sec - 30sec - 180sec * The option in the parentheses is available when the "100 SmartBeaconing" is TYPE1, TYPE 2 or TYPE 3, and the "96 MY POSITION SET" is GPS.
86 DIGI PATH	Digital repeater route setting.	OFF / WIDE1-1 / WIDE1-1, WIDE2-1 / PATH 1 / PATH 2 / PATH 3 / PATH 4 / FULL 1 / FULL 2
87 DIGI PATH 1	Digital repeater route address setting.	ADDRESS 1: - ADDRESS 2: -
88 DIGI PATH 2		
89 DIGI PATH 3		
90 DIGI PATH 4		
91 DIGI PATH FULL 1		
92 DIGI PATH FULL 2	Digital repeater route address setting.	ADDRESS 1: - to ADDRESS 8: -
93 CALLSIGN (APRS)	My call sign setting.	***** - **
94 MESSAGE GROUP	Group filter setting for received messages.	GROUP 1: ALL***** GROUP 2: CQ***** GROUP 3: QST***** GROUP 4: YAESU**** GROUP 5: ----- GROUP 6: ----- BULLETIN 1: BLN?***** BULLETIN 2: BLN?----- BULLETIN 3: BLN?-----
95 MESSAGE REPLY	Set automatic response to received messages.	REPLY: OFF / ON CALLSIGN: *****_* REPLY TEXT: -
96 MY POSITION SET	My position setting.	GPS / MANUAL
97 MY POSITION	My position manual setting.	LAT: N 0°00. 00' (° 00") LON: E 0°00. 00' (° 00")
98 MY SYMBOL	My symbol setting.	ICON 1: [/>] Car ICON 2: [/R] REC.Vehicle ICON 3: [/ -] House QTH (VHF) USER: [YY] Yaesu Radios
99 POSITION COMMENT	Set position comment.	Off Duty / En Route / In Service / Returning / Committed / Special / Priority / Custom 0 to Custom 6 / EMERGENCY!
100 SmartBeaconing	Smart beaconing settings.	STATUS: OFF / TYPE1 / TYPE2 / TYPE3 * For details on the following setting items for each type, refer to the APRS Instruction Manual. LOW SPEED, HIGH SPEED, SLOW RATE, FAST RATE, TURN ANGLE, TURN SLOPE, TURN TIME
101 SORT FILTER	Sort function / Filter function settings.	SORT: TIME / CALLSIGN / DISTANCE FILTER: ALL / MOBILE / FREQUENCY / OBJECT/ITEM / DIGIPEATER / VoIP / WEATHER / YAESU / OTHER PACKET / CALL RINGER / RANGE RINGER / 1200 bps / 9600 bps

Menu Number / Item	Description	Selectable options (Options in bold are the default settings)
102 VOICE ALERT	Voice alert function settings.	VOICE ALERT: NORMAL / TONE SQL DCS / RX-TSQL / RX-DCS TONE SQL: 67.0Hz - 100.0Hz - 254.1Hz DCS: 023 - 754
103 STATION LIST	Displays the APRS Station list screen.	–
104 MESSAGE LIST	Displays the APRS Message list screen.	–
105 BEACON TX SELECT	Beacon automatic transmit / Manual transmit switch.	MANUAL / AUTO / (SmartBeaconing)* * The option in the parentheses is available when the "100 SmartBeaconing" is TYPE1, TYPE 2 or TYPE 3, and the "96 MY POSITION SET" is GPS.
106 BEACON TX	Manual beacon transmission (one time)	–

SD CARD

107 BACKUP

WRITE TO SD	Saves the transceiver setting information to a microSD memory card.	
ALL MEMORY SETUP	Copies all data. Copies only the memory channels and backtrack position information. Copies only the set-up menu settings.	
READ FROM SD	Loads the information to the transceiver from a microSD memory card.	
ALL MEMORY SETUP	Copies all data. Copies only the memory channels and backtrack position information. Copies only the set-up menu settings.	
108 MEMORY INFO	Displays the total capacity and free space of the MicroSD Card.	–
109 FORMAT	Initializing the micro-SD card.	–

OPTION

111 Bluetooth

Bluetooth	Bluetooth headset setting.	OFF / ON
DEVICE	Bluetooth device list.	–
STATUS	Display the connection status of Bluetooth devices.	–
AUDIO	Set whether received audio is heard from both the Bluetooth® headset and the transceiver speaker, or only from the connected Bluetooth® device.	AUTO / FIX

112 VOICE MEMORY (Requires optional Voice Guide Unit FVS-2)

PLAY/REC	Recording operation settings.	FREE 5min / LAST 30sec
ANNOUNCE	Setting conditions for frequency announcement.	AUTO / OFF / MANUAL
LANGUAGE	Setting the language to announce.	ENGLISH / JAPANESE
VOLUME	Setting the announcement volume.	HIGH / MID / LOW
RX MUTE	Setting to mute received audio during announcements and playback.	ON / OFF
113 FVS REC	Start recording the received audio.	–
114 TRACK SELECT	Selecting the audio track to play.	ALL / 1 - 8
115 FVS PLAY	Start playing the recorded sound	–
116 FVS STOP	Stop recording / playing	–
117 FVS CLEAR	Erase all recorded audio	–
118 VOICE GUIDE	The frequency of the operating band will be announced.	–

Menu Number / Item	Description	Selectable options (Options in bold are the default settings)
--------------------	-------------	--

CLONE

119 This → Other	Send all settings to other FTM-500D	–
120 Other → This	Receive all settings from other FTM-500D	–

RESET

121 CALLSIGN	My call sign setting. (10 characters)	*****
122 MEMORY CH RESET	Erase registered memory channels.	–
123 APRS RESET	Return APRS settings to default.	–
124 CONFIG SET	Save configuration.	–
125 CONFIG RECALL	Recall configuration.	–
126 SOFTWARE VERSION	Display the software version.	Main Ver. / Sub Ver. / DSP Ver.
127 FACTORY RESET	Return all settings to factory default.	–

Setup Menu Operations

DISPLAY

1 FREQUENCY INPUT

In VFO mode, the screen for direct input of frequency is displayed, and in memory mode, the screen for direct input of Memory Channel number is displayed. Select the [MEMORY CH LIST] button on this screen and press **FUNC** knob to open the memory channel list screen.

1. Press and hold the **FUNC** knob → [1 FREQUENCY INPUT] → Press the **FUNC** knob
2. Rotate the **FUNC** knob to select a number and press the **FUNC** knob to enter.

NOTE: This item is registered in the custom function menu by factory setting.

2 LCD BRIGHTNESS

The brightness of the display and key buttons can be changed.

1. Press and hold the **FUNC** knob → [2 LCD BRIGHTNESS] → Press the **FUNC** knob
2. Rotate the **FUNC** knob to select the brightness from the following 3 levels:

MIN / MID / MAX

3 FREQUENCY COLOR

The display color of the frequency of the operation band can be changed.

1. Press and hold the **FUNC** knob → [3 FREQUENCY COLOR] → Press the **FUNC** knob
2. Rotate the **FUNC** knob to select the display color:

WHITE / BLUE / RED

4 BAND SCOPE

Set the number of channels to be displayed when the BAND SCOPE function is used.

1. Press and hold the **FUNC** knob → [4 BAND SCOPE] → Press the **FUNC** knob
2. Rotate the **FUNC** knob to select the number of channels to search.

WIDE	61 channels (VFO mode), 21 channels (Memory mode)
NARROW	31 channels (VFO mode), 11 channels (Memory mode)

Refer to the Operating Manual for details.

5 LOCATION INFO

Set the display presentation on the smart navigation screen.

1. Press and hold the **FUNC** knob → [5 LOCATION INFO] → Press the **FUNC** knob
2. Rotate the **FUNC** knob to select what is displayed on the screen.

COMPASS	Displays the compass.
NUMERIC	Displays the latitude and longitude.

6 COMPASS

Set the compass display.

1. Press and hold the **FUNC** knob key → [**6 COMPASS**] → Press the **FUNC** knob
2. Rotate the **FUNC** knob to select the desired setting.

HEADING UP	The heading direction is indicated at the top of the compass.
NORTH UP	The north direction is indicated at the top of the compass.

The default setting: HEADING UP

7 DISPLAY MODE

Displays screens for additional functions.

1. Press and hold the **FUNC** knob key → [**7 DISPLAY MODE**] → Press the **FUNC** knob
2. Rotate the **FUNC** knob to select the function to be displayed then Press the **FUNC** knob.

BACKTRACK: Backtrack screen (Page 18)

ALTITUDE: Altitude screen (Page 22)

TIMER/CLOCK: Timer/Clock screen (Page 23)

GPS INFORMATION: GPS Information screen (Page 21)



TX

8 TX POWER

Set the transmit power output.

1. Press and hold the **FUNC** knob → [**8 TX POWER**] → Press the **FUNC** knob
2. Rotate the **FUNC** knob to select the TX power output.

“**LOW**” ↔ “**MID**” ↔ “**HIGH**”

HIGH	MID	LOW
		
50 W	25 W	5 W

NOTE: This item is registered in the custom function menu by factory setting.

9 AMS TX MODE

When operating in the AMS function, the transmit mode may be selected:

1. Press and hold the **FUNC** knob → [**9 AMS TX MODE**] → Press the **FUNC** knob
2. Rotate the **FUNC** knob to select the AMS transmit mode.

Transmit Mode	Transmit	Receive
AUTO (default)	Automatically transmits in the communication mode selected by the AMS function.	Automatically selects the receive mode corresponding to the received signal.
TX FM FIXED	Always transmits in the analog FM mode.	
TX DN FIXED (TX DIGITAL)	Always transmits in the DN mode.	

Refer to the Operating Manual for details.

10 MIC GAIN

The sensitivity (gain) of the microphone can be adjusted.

1. Press and hold the **FUNC** knob → [**10 MIC GAIN**] → Press the **FUNC** knob
2. Rotate the **FUNC** knob to select the desired setting.

The sensitivity can be selected from the following 5 levels.

MIN / LOW / **NORMAL** / HIGH / MAX

11 VOX

Set the VOX (Voice Operated Transmit) function ON/OFF, and VOX delay time.

1. Press and hold the **FUNC** knob → [**11 VOX**] → Press the **FUNC** knob

Refer to the Operating Manual for details.

12 AUTO DIALER

Set method (Auto or Manual) to transmit the registered DTMF code.

1. Press and hold the **FUNC** knob → **[12 AUTO DIALER]** → Press the **FUNC** knob
2. Rotate the **FUNC** knob to select the desired setting.

ON	The auto dialer function is enabled.
OFF	The auto dialer function is disabled.

For details, see “Setting the auto dialer function” (page 16).

13 TOT

The transceiver will automatically return to receive after transmitting continuously for a specified time.

1. Press and hold the **FUNC** knob → **[13 TOT]** → Press the **FUNC** knob
2. Rotate the **FUNC** knob to select the desired setting.

OFF / 1 min / 2 min / 3 min / 5 min / 10 min / 15 min / 20 min / 30 min



When the time-out-timer is active, a beep is sounded when a continuous transmission nears the set time. About 10 seconds later, the transceiver returns to the receive mode.

The default settings depend on the transceiver version.

14 DIGITAL VW

Set the digital voice VW (Voice FR) mode selection.

1. Press and hold the **FUNC** knob → **[14 DIGITAL VW]** → Press the **FUNC** knob
2. Rotate the **FUNC** knob to select the desired setting.

ON	The digital voice VW (Voice FR) mode may be selected.
OFF	The digital voice VW (Voice FR) mode may not be selected.

15 FM BANDWIDTH

The modulation can be set to half of its usual level.

Select "WIDE" for normal amateur radio operation.

1. Press and hold the **FUNC** knob → [**15 FM BANDWIDTH**] → Press the **FUNC** knob
2. Rotate the **FUNC** knob to select the desired setting.

WIDE	Normal transmit modulation level.
NARROW	Modulation is half of the normal level.

16 RX MODE

Manually switch to a suitable mode (radio wave type) for the operating frequency band.

1. Press and hold the **FUNC** knob → [**16 RX MODE**] → Press the **FUNC** knob
2. Rotate the **FUNC** knob to select the mode.

AUTO	Automatically switches the modulation mode to match the frequency band.
FM	Switches to the FM mode.
AM	Switches to the AM mode.

17 SUB BAND

The Sub Band display (lower part of the screen) can be hidden. Also, while receiving a signal on the Main Band, the Sub Band audio can be automatically muted.

1. Press and hold the **FUNC** knob → [**17 SUB BAND**] → Press the **FUNC** knob
The parameter settings screen appears.

SUB BAND

The Sub Band display is hidden.

1. Rotate the **FUNC** knob to select [**SUB BAND**] then Press the **FUNC** knob.
2. Rotate the **FUNC** knob to select the desired setting then press the **FUNC** knob.

OFF	The Sub Band (Lower part of the screen) is not displayed.
ON	The Sub Band (Lower part of the screen) is displayed.

SUBBAND MUTE

The receive audio of the Sub Band can be automatically muted when receiving signals in the Main Band.

1. Rotate the **FUNC** knob to select [**SUBBAND MUTE**] then press the **FUNC** knob.
2. Rotate the **FUNC** knob to select the desired setting.

OFF	The Sub Band audio will not be muted when a signal is received on the Main Band.
ON	The Sub Band audio will be muted when a signal is received on the Main Band.

18 AUDIO EQUALIZER

Set up the AESS dual speaker system that uses both the front speakers and the main unit speakers.

1. Press and hold the **FUNC** knob → [18 AUDIO EQUALIZER] → Press the **FUNC** knob
2. Press the **FUNC** knob.
3. Rotate the **FUNC** knob to set the sound quality of the front speaker.

OFF	Standard sound quality without AESS.
FLAT	Use AESS without changing sound quality.
HIGH PITCH	Emphasizes high frequencies.
LOW PITCH	Emphasizes low frequencies
BPF	Attenuates high and low frequencies

4. Press the **FUNC** knob.
5. Similarly, rotate the **FUNC** knob to select each item of “REAR TONE”, “REAR OUT” and “AESS PHASE”, then press the **FUNC** knob.

FRONT TONE

OFF	Standard sound quality without AESS. (When set to OFF, only “REAR OUT” cannot be set.)
FLAT	Use AESS without changing sound quality.
HIGH PITCH	Emphasizes high frequencies.
LOW PITCH	Emphasizes low frequencies
BPF	Attenuates high and low frequencies

REAR TONE

FLAT	Use AESS without changing sound quality.
HIGH PITCH	Emphasizes high frequencies.
LOW PITCH	Emphasizes low frequencies
BPF	Attenuates high and low frequencies
1kHz	Cuts high frequencies above 1kHz
700Hz	Cuts high frequencies above 700Hz

REAR OUT

0% - 100%	Output level of the main body speaker.
-----------	--

AESS PHASE

OFF	Use AESS without changing the time delay.
1.25ms - 20.00ms	Sets the time delay between the audio output of the control head speaker and the main unit speaker..

MEMORY

19 HOME CH

Recalls the home channel of the current band.

1. Press and hold the **FUNC** knob → [**19 HOME CH**] → Press the **FUNC** knob

NOTE: This item is registered in the custom function menu by factory setting.

20 MEMORY LIST

Displays the Memory channel list screen.

1. Press and hold the **FUNC** knob → [**20 MEMORY LIST**] → Press the **FUNC** knob

21 MEMORY LIST MODE

Set the memory channel list to be displayed by rotating the **DIAL** knob, confirming the contents of the memory, and then press **DIAL** knob to recall the memory channel.

1. Press and hold the **FUNC** knob → [**21 MEMORY LIST MODE**] → Press the **FUNC** knob

Refer to the Operating Manual for details.

22 PMG

Cancel the registration of all PMG channels.

1. Press and hold the **FUNC** knob → [**20 PMG**] → Press the **FUNC** knob

The parameter settings screen appears.

PMG TIMER

Scan resume time after there is no signal when receiving in PMG mode simultaneously.

1. Rotate the **FUNC** knob to select [**PMG TIMER**] then Press the **FUNC** knob.
2. Rotate the **FUNC** knob to select the desired setting.

1sec / **2sec** / 3sec

PMG CLEAR

Cancel the registration of all PMG channels..

1. Rotate the **FUNC** knob to select [**PMG CLEAR**] then Press the **FUNC** knob.

The confirmation screen will be displayed.

2. Rotate the **FUNC** knob to select [OK], then press the **FUNC** knob.

CONFIG

23 BEEP

Adjust the volume of the beep that sounds when a key is pressed.

1. Press and hold the **FUNC** knob → **[23 BEEP]** → Press the **FUNC** knob
2. Rotate the **FUNC** knob to select the desired setting.

The Beep volume can be selected from 3 levels.

OFF / **LOW** / HIGH

24 BAND SKIP

Set the band selected when the **[BAND M▶v]** key is pressed.

1. Press and hold the **FUNC** knob → **[22 BAND SKIP]** → Press the **FUNC** knob
2. Rotate the **FUNC** knob to select the band to be set with a Press the **FUNC** knob.
3. Rotate the **FUNC** knob to set "ON" (selectable) or "OFF" (not selectable).

AIR: OFF / **ON** (108MHz - 137MHz)

VHF: OFF / **ON** (137MHz - 174MHz)

UHF: OFF / **ON** (400MHz - 480MHz)

OTHER: OFF / **ON** (174MHz - 400MHz, 480MHz - 999.995MHz)

25 RPT ARS

Set the auto repeater shift function.

1. Press and hold the **FUNC** knob → **[25 RPT ARS]** → Press the **FUNC** knob
2. Rotate the **FUNC** knob to select the desired setting.

AUTO	The auto repeater shift function is enabled.
OFF	The auto repeater shift function is disabled.

NOTE: This item is registered in the custom function menu by factory setting.

26 RPT SHIFT

Set the direction of the repeater transmit shift setting.

1. Press and hold the **FUNC** knob → **[26 RPT SHIFT]** → Press the **FUNC** knob
2. Rotate the **FUNC** knob to select the shift direction setting.

OFF (AUTO)	The transmit frequency will not shift.
-	The transmit frequency will shift down.
+	The transmit frequency will shift up.

27 RPT SHIFT FREQ

Set the repeater transmit shift offset frequency.

1. Press and hold the **FUNC** knob → **[27 RPT SHIFT FREQ]** → Press the **FUNC** knob
2. Rotate the **FUNC** knob to select the desired repeater transmit shift offset frequency.

The offset can be set at 0.05 MHz intervals between 0.00 MHz and 99.95 MHz.

The default setting differs depending on frequency.

28 RPT REVERSE

The “reverse” operation temporarily reverses the transmit and receive frequencies. This permits checking to find if direct communication with the other station is possible.

1. Press and hold the **FUNC** knob → [28 RPT REVERSE] → Press the **FUNC** knob
 - The transmit and receive frequencies are temporarily reversed (“reverse” state).
 - In the “reverse” state, the “-” or “+” blinks on the display.
2. To release the reverse state, repeat the above steps again.

NOTE: This item is registered in the custom function menu by factory setting.

29 MIC PROGRAM KEY

Functions can be assigned to the program keys (P1 to P4) on the provided microphone (SSM-85D).

1. Press and hold the **FUNC** knob → [29 MIC PROGRAM KEY] → Press the **FUNC** knob
Refer to the Operating Manual for details.

30 DATE&TIME ADJUST

Set the date and time of the **FTM-500DR/DE** clock. In the factory default, the date and time are automatically set when acquiring the GPS signals, so in this case no manual setting is necessary.

1. Press and hold the **FUNC** knob → [30 DATE&TIME ADJUST] → Press the **FUNC** knob
2. Press the **FUNC** knob to change the year → month → day → hour → minute.
3. Rotate the **FUNC** knob to change the setting.
4. When “minute” is set and the **FUNC** knob is pressed, the time becomes “00” and the date and time settings are confirmed.

Please note that the setting values will not be saved if the setup menu is exited during setting.

31 DATE&TIME FORMAT

1. Press and hold the **FUNC** knob → [31 DATE&TIME FORMAT] → Press the **FUNC** knob
2. Rotate the **FUNC** knob to select [DATE] or [TIME].
3. Rotate the **FUNC** knob to change the setting.

DATE	yyyy/mmm/dd, dd/mmm/yyyy, yyyy/dd/mmm, mmm/dd/yyyy
TIME	24 hour / 12 hour

32 TIME ZONE

The **FTM-500DR/DE** clock time can be synchronized for the time zone with the time data (Coordinated Universal Time) from the GPS.

1. Press and hold the **FUNC** knob → [32 TIME ZONE] → Press the **FUNC** knob
2. Rotate the **FUNC** knob to select the desired setting.

The time zone can be set at 0.5 hour intervals up to ±14 hours.

The default setting: UTC ±0:00

33 STEP

Set the frequency step when the tuning knob is turned, or when the key is pressed.

1. Press and hold the **FUNC** knob → **[33 STEP]** → Press the **FUNC** knob

Refer to the Operating Manual for details.

34 CLOCK TYPE

The CPU clock signal can be changed so that an internal spurious signal is not heard by the receiver. Select "A" during normal operation.

1. Press and hold the **FUNC** knob → **[34 CLOCK TYPE]** → Press the **FUNC** knob
2. Rotate the **FUNC** knob to select the desired setting.

A	The clock shift operation will automatically switch ON and OFF.
B	The clock shift will always be kept in operation.

35 UNIT

Set the units of measure to display the altitude, distance, and speed.

1. Press and hold the **FUNC** knob → **[35 UNIT]** → Press the **FUNC** knob
2. Rotate the **FUNC** knob to select the desired setting.

INCH	Display units in the Imperial/USA system.
METRIC	Display units in the Metric system.

The default settings depend on the transceiver version.

36 APO

The transceiver can be set to automatically power OFF when there is no operation for a period.

1. Press and hold the **FUNC** knob → **[36 APO]** → Press the **FUNC** knob
2. Rotate the **FUNC** knob to select the desired setting.

OFF	Does not turn the power OFF automatically.
0.5 hour to 12 hour	Turns the power OFF when no operation is performed for a specified time.

37 GPS DATUM

Set the geodetic GPS positioning standard reference system.

1. Press and hold the **FUNC** knob → **[37 GPS DATUM]** → Press the **FUNC** knob
2. Rotate the **FUNC** knob to select the desired setting.

WGS-84	Positions using the global geodetic reference system. This is being used as a standard all around the world.
TOKYO MEAN	Positions using the Japanese geodetic reference system. When positioning in Japan (Tokyo), the error can be made smaller.



Select "WGS-84" for the normal operation.

38 GPS DEVICE

Choose whether to use the built-in GPS or an external GPS device.

1. Press and hold the **FUNC** knob → **[38 GPS DEVICE]** → Press the **FUNC** knob
2. Rotate the **FUNC** knob to select the desired setting.

INTERNAL	Uses built-in GPS.
EXTERNAL	Uses GPS data from an external GPS device connected to the EXT GPS jack on the front panel.



The data transmission speed of the EXT GPS jack is 9600bps and cannot be changed.

39 GPS LOG

Set the time interval for recording GPS position information to the microSD card.

1. Press and hold the **FUNC** knob → **[39 GPS LOG]** → Press the **FUNC** knob
2. Rotate the **FUNC** knob to select the time interval

OFF / 1 sec / 2 sec / 5 sec / 10 sec / 30 sec / 60 sec

If “OFF” is selected, no GPS Information is saved to the microSD memory card.



- Data saved to the microSD memory card is saved in yymmddhhmmss.log format.
- Saved data may be viewed by using OEM PC applications*.

*Yaesu does not provide technical support for PC applications.

AUDIO

40 RECORDING

Set the voice recording function.

1. Press and hold the **FUNC** knob → [40 RECORDING] → Press the **FUNC** knob

Refer to the Operating Manual for details.

41 REC/STOP

Starts or stops voice recording.

1. Press and hold the **FUNC** knob → [41 REC/STOP] → Press the **FUNC** knob

Refer to the Operating Manual for details.

42 FRONT SP MUTE

Front speaker operation settings when external speakers are connected.

1. Press and hold the **FUNC** knob → [42 FRONT SP MUTE] → Press the **FUNC** knob
2. Rotate the **FUNC** knob to select the desired setting.

CONTINUE	The Front speaker audio will not be muted when external speakers are connected.
AUTO MUTE	The Front speaker audio will be muted when external speakers are connected.

SIGNALING

43 DTMF

Select the registered DTMF memory 0 to 9 and press **PTT** to automatically send the DTMF code.

1. Press and hold the **FUNC** knob → **[43 DTMF]** → Press the **FUNC** knob
2. Rotate the **FUNC** knob to select the desired DTMF memory (1 to 9).
3. Press **PTT**.

For details, see “Transmitting DTMF code automatically using DTMF memory” (page 16).

NOTE: This item is registered in the custom function menu by factory setting.

44 DTMF MEMORY

Register the DTMF memory (maximum 16 digits, 9 channels) for automatic transmission with the auto dialer.

1. Press and hold the **FUNC** knob → **[44 DTMF MEMORY]** → Press the **FUNC** knob

For details, see “Registering the DTMF memory” (page 16).

45 SQL TYPE

Selecting the squelch type in the analog FM mode.

1. Press and hold the **FUNC** knob → **[45 SQL TYPE]** → Press the **FUNC** knob

For details, see “Selecting the squelch type in the analog FM mode” (page 9).

NOTE: This item is registered in the custom function menu by factory setting.

46 TONE SQL FREQ / DCS CODE

Set the tone frequency or DCS code.

1. Press and hold the **FUNC** knob → **[46 TONE SQL FREQ]*** or **[46 DCS CODE]*** → Press the **FUNC** knob

*The item name changes automatically depending on the setting of “42 SQL TYPE”.

NOTE: This item is registered in the custom function menu by factory setting.

47 SQL EXPANSION

The squelch type can be set separately for transmit and receive.

1. Press and hold the **FUNC** knob → **[47 SQL EXPANSION]** → Press the **FUNC** knob
2. Rotate the **FUNC** knob to select the desired setting.

ON	Add squelch types for signaling.
OFF	Does not add squelch types for signaling.

48 PAGER CODE

The new pager code permits calls to specific stations only.

1. Press and hold the **FUNC** knob → **[48 PAGER CODE]** → Press the **FUNC** knob

For details, see “Setting the Code for this Station” (page 12).

49 PR FREQUENCY

Set a no-communication squelch CTCSS tone from 300 Hz to 3000 Hz in 100 Hz steps.

1. Press and hold the **FUNC** knob → **[49 PR FREQUENCY]** → Press the **FUNC** knob
2. Rotate the **FUNC** knob to select the desired CTCSS tone frequency.
300Hz to 3000Hz (100Hz steps)

50 BELL RINGER

The beep may be set to sound an alert when a call is received from another station.

1. Press and hold the **FUNC** knob → **[50 BELL RINGER]** → Press the **FUNC** knob
- For details, see “Notification of a Call from a Remote Station by the Bell Function” (page 13).

51 WX ALERT

Setting the weather Alert Feature, to notify of storms and hurricanes, ON or OFF.

1. Press and hold the **FUNC** knob → **[51 WX ALERT]** → Press the **FUNC** knob
2. Press the **FUNC** knob to select the desired setting.

ON	Enables the Weather Alert Feature.
OFF	Disables the Weather Alert Feature.

SCAN

52 SCAN

Start or stop scanning for channels in VFO mode or Memory mode.

1. Press and hold the **FUNC** knob → [**52 SCAN**] → Press the **FUNC** knob

Refer to the Operating Manual for details.

NOTE: This item is registered in the custom function menu by factory setting.

53 DUAL RCV MODE

Activate the Priority Scan function or A-B Dual Receive function.

1. Press and hold the **FUNC** knob → [**53 DUAL RCV MODE**] → Press the **FUNC** knob
2. Rotate the **DIAL** knob to select the desired setting.

OFF / PRIORITY SCAN

Refer to the Operating Manual for details.

54 DUAL RX INTERVAL

Set the time interval to check for a signal on the priority channel (HOME channel) during the priority scan.

1. Press and hold the **FUNC** knob → [**54 DUAL RX INTERVAL**] → Press the **FUNC** knob
2. Rotate the **FUNC** knob to select the desired setting.

0.5sec / 1.0sec / 2.0sec / 3.0sec / **5.0sec** / 7.0sec / 10sec

Refer to the Operating Manual for details.

55 PRIORITY REVERT

Set to always Transmit on the priority channel (HOME channel) when PTT is pressed during dual receive operation.

1. Press and hold the **FUNC** knob → [**55 PRIORITY REVERT**] → Press the **FUNC** knob
2. Rotate the **DIAL** knob to select the desired setting.

ON	Always send on the priority channel (HOME channel).
OFF	Sends at the currently displayed frequency.

56 SCAN RESUME

Set the time interval to resume scanning after a received signal ends during scanning.

1. Press and hold the **FUNC** knob → [**56 SCAN RESUME**] → Press the **FUNC** knob
2. Rotate the **DIAL** knob to select the desired setting.

BUSY	Continue receiving the frequency until the signal disappears.
HOLD	Stop scanning and receive that frequency.
1 sec / 3 sec / 5 sec	Restart scanning after receiving the frequency for the set amount of time.

The default settings depend on the transceiver version.

DIGITAL

57 DIGITAL POPUP

Set the time duration to display the remote station information (such as the call sign) on the LCD.

1. Press and hold the **FUNC** knob → **[57 DIGITAL POPUP]** → Press the **FUNC** knob
2. Rotate the **FUNC** knob to select the desired setting.

OFF	The remote station information is not displayed.
2 sec - 10 sec - 60 sec	Set the time duration to display the remote station information.
CONTINUE	The remote station information is continuously displayed.

58 LOCATION SERVICE

Set whether to transmit this station position in digital mode.

1. Press and hold the **FUNC** knob → **[58 LOCATION SERVICE]** → Press the **FUNC** knob
2. Rotate the **FUNC** knob to select the desired setting.

ON	Send the location information of this station.
OFF	Do not send the location information of this station.

59 STANDBY BEEP

Set whether or emit the standby beep sound when the remote station completes transmission.

1. Press and hold the **FUNC** knob → **[59 STANDBY BEEP]** → Press the **FUNC** knob
2. Rotate the **FUNC** knob to select the desired setting.

ON	Emits the standby beep sound.
OFF	Does not emit the standby beep sound.

GM

For details on setting each item, refer to “FTM-500DR/DE GM Function Instruction Manual” which is available on Yaesu website.

WIRES-X

For details on setting each item, refer to “FTM-500DR/DE WIRES-X Instruction Manual” which is available on Yaesu website.

69 COM PORT

Set the communication speed and parameters for the COM port DATA jack on the rear panel of the transceiver.

1. Press and hold the **FUNC** knob key → **[69 COM PORT]** → Press the **FUNC** knob
The parameter settings screen appears.

SPEED

Setting the communication speed.

1. Rotate the **FUNC** knob to select **[SPEED]** then Press the **FUNC** knob.
2. Rotate the **FUNC** to select the desired communication speed then press the **FUNC** knob.

The setting switches as follows:

4800bps / **9600bps** / 19200bps / 38400bps / 57600bps

OUTPUT

Select the function of COM port output.

1. Rotate the **FUNC** knob to select **[OUTPUT]** then Press the **FUNC** knob.
2. Rotate the **FUNC** to select the data output type then press the **FUNC** knob.

OFF	The COM port is deactivated.
GPS OUT	Outputs the GPS receiver satellite data.
PACKET	Outputs the AX.25 packet data from the internal modem.
WAYPOINT	Outputs the APRS packet WAYPOINT beacon information of other stations acquired from the received data.

WP FORMAT

Set the number of digits for CALLSIGN information of APRS BEACON stations, attached to various data, when WAYPOINT is selected for OUTPUT.

1. Rotate the **FUNC** knob to select **[WP FORMAT]** then press the **FUNC** knob.
2. Press the **FUNC** to select the number of digits of the APRS beacon station call sign information which is added to each data.

NMEA 9	Displays the last 9 digits of the call sign (Example: JA1YOE-14 is output as "JA1YOE-14").
NEMA 8	Displays the last 8 digits of the call sign (Example: JA1YOE-14 is shortened to "A1YOE-14").
NMEA 7	Displays the last 7 digits of the call sign (Example: JA1YOE-14 is shortened to "1YOE-14").
NMEA 6	Displays the last 6 digits of the call sign (Example: JA1YOE-14 is shortened to "YOE-14").

WP FILTER

Sets the type of beacon to be output when "WAYPOINT" is selected in "OUTPUT".

1. Rotate the **FUNC** knob to select **[WP FILTER]** then press the **FUNC** knob.
2. Rotate the **FUNC** to select the beacon type you want to output then press the **DIAL** knob.

ALL	Outputs all the received beacons.
MOBILE	Outputs only mobile station beacons.
FREQUENCY	Outputs only the beacons of stations with frequency information.
OBJECT/ITEM	Outputs only the beacons of object stations or item stations.
DIGIPEATER	Outputs only the beacons of digital repeater stations.
VoIP	Outputs only beacons of VoIP stations such as WIRES.
WEATHER	Outputs only beacons of the weather stations.
YAESU	Outputs only beacons of stations using Yaesu transceivers.
CALL RINGER	Outputs only the information of call sign ringer stations which are set from [80 APRS RINGER (CS)] in the APRS Setup menu.
RANGE RINGER	Outputs only the information of stations recognized as an approaching station by the [79 APRS RINGER] range ringer function in the APRS Setup menu.

70 DATA BAND

Set the operating band of the APRS (internal modem) and data communication (when using the DATA jack at the back of the main body).

1. Press and hold the **FUNC** knob key → [70 DATA BAND] → Press the **FUNC** knob

APRS

Sets the APRS operating band.

1. Rotate the **FUNC** knob to select [**APRS**] then press the **FUNC** knob.
2. Rotate the **FUNC** to select the APRS operating band, then press the **FUNC** knob.

MAIN BAND	Always operate on the Main Band (upper region of the screen).
SUB BAND	Always operate on the Sub Band (lower area of the screen).
THIS BAND	Setting this Menu item, fixes APRS operation to the Band displayed at the top of the screen. By pressing the [↕] key, the upper and lower bands are exchanged. The APRS operation Band is also exchanged, and the display of this setting value changes to "OTHER BAND".
OTHER BAND	Setting this menu item, fixes APRS operation to the band displayed at the bottom of the screen. By pressing the [↕] key, the upper and lower bands are exchanged. The APRS operation Band is also exchanged, and the display of this setting value changes to "THIS BAND".

DATA

Sets the data transmission operating band.

1. Rotate the **FUNC** knob to select [**DATA**] then press the **FUNC** knob.
2. Rotate the **FUNC** to select the DATA communication operating band, then press the **FUNC** knob.

MAIN BAND	Always operate on the Main Band (upper region of the screen).
SUB BAND	Always operate on the Sub Band (lower area of the screen).
THIS BAND	Setting this Menu item, fixes DATA operation to the Band displayed at the top of the screen. By pressing the [↑↓] key, the upper and lower bands are exchanged. The DATA operation Band is also exchanged, and the display of this setting value changes to "OTHER BAND".
OTHER BAND	Setting this menu item, fixes DATA operation to the band displayed at the bottom of the screen. By pressing the [↑↓] key, the upper and lower bands are exchanged. The DATA operation Band is also exchanged, and the display of this setting value changes to "THIS BAND".

71 DATA SPEED

Set the baud rate of the APRS (internal modem), and the data communication (when using the DATA jack at the back of the main body).

1. Press and hold the **FUNC** knob → [71 DATA SPEED] → Press the **FUNC** knob
The screen for the detailed settings will be displayed.

APRS

Sets the APRS packet communication speed.

1. Rotate the **FUNC** knob to select [APRS] then press the **FUNC** knob.
2. Rotate the **FUNC** to select the APRS communication speed, then press the **FUNC** knob.

The setting switches as follows:

1200 bps / 9600 bps

DATA

Sets the APRS data communication speed.

1. Rotate the **FUNC** knob to select [DATA] then press the **FUNC** knob.
2. Rotate the **FUNC** to select the data communication speed, then press the **FUNC** knob.

The setting switches as follows:

1200 bps / 9600 bps

72 DATA SQL

Sets the squelch detection status during APRS (internal modem) operation, and the output status of the squelch terminal of the “DATA” communications jack on the rear panel of the transceiver.

1. Press and hold the **FUNC** knob → [72 DATA SQL] → Press the **FUNC** knob
The screen for the detailed settings will be displayed.

APRS

Selects the squelch detection status during APRS operation.

1. Rotate the **FUNC** knob to select [**APRS**] then press the **FUNC** knob.
2. Rotate the **FUNC** to select the desired setting, then press the **FUNC** knob.

RX BAND	Does not transmit when the receive band squelch is open.
TX/RX BAND	Does not transmit when either the receive band or transmit band squelch is open.

DATA

Sets the output status (during receive) of the PK SQL (squelch control) terminal (6 pin) on the DATA Jack.

1. Rotate the **FUNC** knob to select [**DATA**] then press the **FUNC** knob.
2. Rotate the **FUNC** to select the desired setting, then press the **FUNC** knob.

RX BAND	The SQL terminal is active when the receive band squelch is open.
TX/RX BAND	The SQL terminal is active when either the receive band or the transmit band squelch is open.

TX

Sets the output status (during transmission) of the PK SQL (squelch control) terminal (6 pin) on the DATA Jack.

Sets whether to activate the SQL terminal while the “DATA” set in the Menu “70 DATA BAND” is being transmitted.

When set to “ON”, transmission from an external device such as a TNC may be suppressed while this unit is transmitting in the data band.

1. Rotate the **FUNC** knob to select [**TX**] then press the **FUNC** knob.
2. Rotate the **FUNC** to select the desired setting, then press the **FUNC** knob.

ON	The SQL terminal becomes active during transmission.
OFF	The SQL terminal does not become active during transmission.

APRS

The APRS of the transceiver is a communication system for data such as messages and station positions using the APRS format. Refer to the separate Operating Manual APRS Edition for details (download the manual from the YAESU website).

SD CARD

107 BACKUP

The transceiver settings information can be saved to a microSD memory card, also the saved information can be loaded to the transceiver.

1. Press and hold the **FUNC** knob → **[107 BACKUP]** → Press the **FUNC** knob
2. Rotate the **FUNC** knob to select the operation to be performed.

WRITE TO SD	Saves the transceiver setting information to a microSD memory card.
READ FROM SD	Loads the information to the transceiver from a microSD memory card.

3. Press the **FUNC** knob.
The copy direction selection screen will be displayed.
4. Rotate the **FUNC** knob to select the file to be copied, then press the **FUNC** knob.
The confirmation screen will be displayed.

ALL	Copies all data.
MEMORY	Copies only the memory channels and backtrack position information.
SETUP	Copies only the set-up Menu settings.

5. Rotate the **FUNC** knob to select **[OK]**, then press the **FUNC** knob.
“Completed” will be displayed when the copying is completed.

108 MEMORY INFO

Display information from SD Memory Card.

1. Press and hold the **FUNC** knob → **[108 MEMORY INFO]** → Press the **FUNC** knob
The bar graph and the following information will be displayed:
Used space : xx,xxx MB
Free space : xx,xxx MB
Capacity : xx,xxx MB

109 FORMAT

Initialize a new micro-SD memory card.



Formatting a microSD memory card erases all data saved on it. Before formatting the card, be sure to check for data and save it before formatting.

1. Press and hold the **FUNC** knob → **[109 FORMAT]** → Press the **FUNC** knob
The confirmation screen will be displayed.
2. To format the microSD card, turn the **FUNC** knob to select **[OK]** and then press the **FUNC** knob.

Refer to the Operating Manual for details.

OPTION

111 Bluetooth

Make Bluetooth® settings and connect to the optional Bluetooth Headset SSM-BT10.

1. Press and hold the **FUNC** knob → [**111 Bluetooth**] → Press the **FUNC** knob

Refer to the Operating Manual for details.

112 VOICE MEMORY

Make settings related to the (optional) FVS-2 voice guide unit attached to the transceiver.

1. Press and hold the **FUNC** knob → [**112 VOICE MEMORY**] → Press the **FUNC** knob

Refer to “Using the voice memory” (page 26) for details.

113 FVS REC

Start recording the received audio using the (optional) FVS-2 voice guide unit.

1. Press and hold the **FUNC** knob → [**113 FVS REC**] → Press the **FUNC** knob

Refer to “Recording the receive audio” (page 27) for details.

114 TRACK SELECT

Select the track to play on the (optional) FVS-2 voice guide unit.

1. Press and hold the **FUNC** knob → [**114 TRACK SELECT**] → Press the **FUNC** knob

Refer to “Selecting the track” (page 27) for details.

115 FVS PLAY

Plays the audio recorded of the (optional) FVS-2 voice guide unit.

1. Press and hold the **FUNC** knob → [**115 FVS PLAY**] → Press the **FUNC** knob

Refer to “Replaying the recorded audio” (page 27) for details.

116 FVS STOP

Stops playback or recording of the (optional) FVS-2 voice guide unit.

1. Press and hold the **FUNC** knob → [**116 FVS STOP**] → Press the **FUNC** knob

117 FVS CLEAR

All audio recorded using the (optional) FVS-2 voice guide unit is erased at once.

1. Press and hold the **FUNC** knob → [**117 FVS CLEAR**] → Press the **FUNC** knob

Refer to “Erasing the recorded audio” (page 27) for details.

118 VOICE GUIDE

Use the (optional) FVS-2 voice guide unit to announce the operating frequency by voice.

1. Press and hold the **FUNC** knob → [**118 VOICE GUIDE**] → Press the **FUNC** knob

Refer to “Voice announcement of the operating frequency” (page 28) for details.

CLONE

All the data saved on the transceiver directory may be copied (Cloned) to other **FTM-500DR/DE** transceivers.

For details, see “Copying the Radio Data to another Transceiver” (page 30).

RESET

You can restore the settings and memory contents of the transceiver to the factory default settings, and use the preset functions.

121 CALLSIGN

The call sign ID registered to the transceiver may be changed using the set menu.

1. Press and hold the **FUNC** knob → [**121 CALLSIGN**] → Press the **FUNC** knob
2. Press the **FUNC** knob.
The first letter of the call sign ID blinks.
3. Rotate the **FUNC** knob to select the desired letter then press the **FUNC** knob.
The cursor moves to the right.
 - Up to 10 alphanumeric characters including hyphen and slash may be input.
4. Repeat step 3 to complete to inputting the new call sign.
5. Press and hold the **FUNC** knob.

122 MEMORY CH RESET

Delete the registered data from the memory channels.

1. Press and hold the **FUNC** knob → [**122 MEMORY CH RESET**]
2. Press the **FUNC** knob.
The confirmation screen will be displayed.
3. Rotate the **FUNC** knob to select [**OK**], then press the **FUNC** knob.
Erase all memory channels and the transceiver will restart.

123 APRS RESET

Reset the APRS setting.

1. Press and hold the **FUNC** knob → [**123 APRS RESET**] → Press the **FUNC** knob
2. Press the **FUNC** knob.
The confirmation screen will be displayed.
3. Rotate the **FUNC** knob to select [**OK**], then press the **FUNC** knob.
Erase all APRS settings and it will restart automatically.

124 CONFIG SET

Current all settings can be registered to the preset.

1. Press and hold the **FUNC** knob → [**124 CONFIG SET**] → Press the **FUNC** knob
2. Press the **FUNC** knob.
The confirmation screen will be displayed.
3. Rotate the **FUNC** knob to select [**OK**], then press the **FUNC** knob.
“Completed” will be displayed when the preset registration is completed.

125 CONFIG RECALL

Recalls all settings registered in the preset.

1. Press and hold the **FUNC** knob → [125 CONFIG RECALL] → Press the **FUNC** knob
2. Press the **FUNC** knob.
The confirmation screen will be displayed.
3. Rotate the **FUNC** knob to select [OK], then press the **FUNC** knob.
The registered presets will be recalled, "Completed" will be displayed, and then the transceiver will automatically restart.

126 SOFTWARE VERSION

Display the software versions.

1. Press and hold the **FUNC** knob → [126 SOFTWARE VERSION] → Press the **FUNC** knob
The software versions of "Main", "Sub" and "DSP" are shown.

127 FACTORY RESET

To restore all transceiver settings and memory content to the factory defaults.

1. Press and hold the **FUNC** knob → [127 FACTORY RESET] → Press the **FUNC** knob
The confirmation screen will be displayed.
2. Rotate the **FUNC** knob to select [OK] then press the **FUNC** knob.
When all information is erased, the transceiver will automatically restart, and the call sign input screen will be displayed.

The folder configuration of the micro-SD card

A commercially available microSD memory card may be inserted into the **FTM-500DR/DE** to save various data files. The parameters of each function are stored in the following folders.

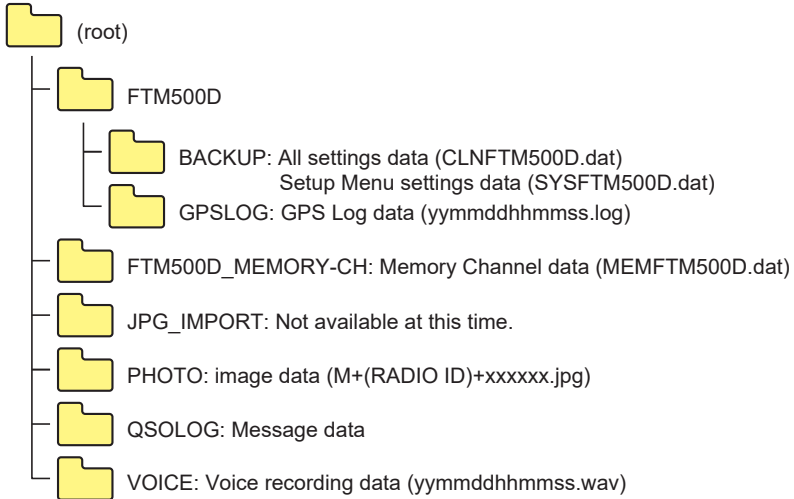

The [yymmddhhmmss] part of the file name consists of year (yy), month (mm), day (dd), hour (hh), minute (mm), and second (ss).

Maintenance

Care and maintenance

Turn the power OFF before wiping away any dust and stains on the transceiver with a dry soft cloth. For stubborn stains, slightly moisten a soft cloth and wring it out before using it to wipe away the stains.



Never use washing detergents and organic solvents (thinner, benzene, etc.). Doing so may result in paint flaking or damage to the transceiver finish.

Replacing the fuse

When the fuse of the DC power supply cable blows and the transceiver becomes inoperable, correct the cause of the problem, and then replace the fuse with a new one of the correct (15 Amp) rating.



When replacing the fuse, be sure to disconnect the power supply cable from the transceiver and from the external DC power supply.

● Replacing the fuse of the DC power supply cable

1. Prepare a new fuse.

Use a fuse with a rating of 15A.



Never attempt to use a fuse that is not of the specified rating

2. Open the fuse holder as shown in the diagram on the right.

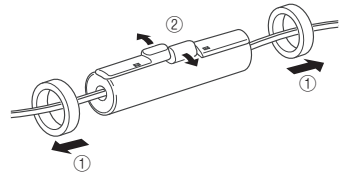

3. Remove the blown fuse.

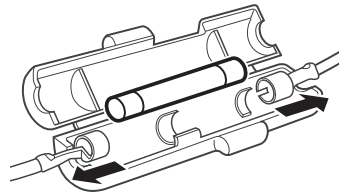

4. Attach the new fuse.
5. Close the fuse holder.

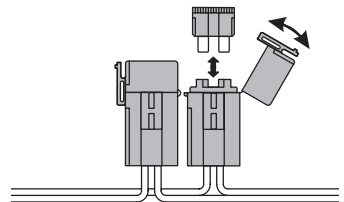

European version

Troubleshooting

Check the following before requesting repair services.

There is no power

- **Is the external power supply connected correctly?**
Connect the black wire to the negative (-) terminal and the red wire to the positive (+) terminal.
- **Is the voltage and current capacity of the external power supply sufficient?**
Check the voltage and current capacity of the external power supply.
Voltage: 13.8V
Current capacity: 15A or higher
- **Is the fuse blown?**
Replace the fuse.

There is no sound

- **Is the squelch level or setting too high?**
Adjust the squelch level when receiving weak signals.
- **Is the volume low?**
Increase the volume by turning the VOL/SQL knob in the clockwise direction.
- **Is the tone squelch or DCS set to on?**
When the tone squelch or DCS is turned on, no sound will be heard until signals containing the set tone frequency or DCS code corresponding to the set code are received.
- **Is the C4FM digital mode on?**
When the AMS function is on, the sound is not output until the transceiver receives an Analog FM mode signal. Also, when the DG-ID function is ON, and the DG-ID number to other than "00", the sound is not output until the transceiver receives a signal with a corresponding DG-ID number.
- **Is the external speaker connected?**
Properly connect a speaker with an impedance of 4 to 16Ω.
- **Is the Bluetooth® headset in use?**
Turn OFF the power of the Bluetooth® headset, or turn OFF the Bluetooth® function in the setup menu.

There is no transmission

- **Is the PTT button pressed properly?**
- **Is the microphone connected correctly?**
Plug the connector all the way into the MIC jack.
- **Is the transmit frequency set to the amateur band?**
Transmission outside the amateur band is not possible.
- **Is the antenna or co-axial cable broken?**
Replace the antenna or co-axial cable.
- **Is the voltage of the external power supply normal?**
When the voltage of the power supply drops during transmission, the transceiver may not run at full performance. Use a stable DC power supply with a voltage of 13.8V and a current capacity of 15A.

The keys or knobs do not operate

- **Is the lock function activated?**
Cancel the lock by briefly pressing the Power switch.

YAESU

Radio for Professionals

Copyright 2023
YAESU MUSEN CO., LTD.
All rights reserved.

No portion of this manual may be
reproduced without the permission of
YAESU MUSEN CO., LTD.

YAESU MUSEN CO., LTD.

Omori Bellport Building D-3F
6-26-3 Minami-Oi, Shinagawa-ku, Tokyo, 140-0013, Japan

YAESU USA

6125 Phyllis Drive, Cypress, CA 90630, U.S.A.

YAESU UK

Unit 12, Sun Valley Business Park, Winnall Close
Winchester, Hampshire, SO23 0LB, U.K.