

# RF μTUNING KIT OPERATING MANUAL

Congratulations on your purchase of the YAESU RF μTUNING KIT.

This operating manual will help you discover the full capability of the RF μTUNING KIT. Please read this manual before beginning installation of the Kit.

## NOTICE

- Do not modify or change the μTUNE UNIT
- Be Carefully to avoid miss-connections
- 3 Do not place the μTUNE UNIT on an unstable location and where objects will fall onto it from above
- Ensure adequate ventilation around the RF μTUNING KIT
- Do not stretch or pinch the cables
- 6 Do not apply any incorrect voltage to the μTUNE UNIT
- Do not install this apparatus in a location with exposure to direct sunshine
- Keep this equipment out of the reach of small children
- Do not wipe the case with chemicals such as thinner or benzene

## INTERCONNECTIONS (PLEASE TURN OFF THE TRANSCEIVER BEFORE CONNECTING CABLES)

### SINGLE CONNECTION

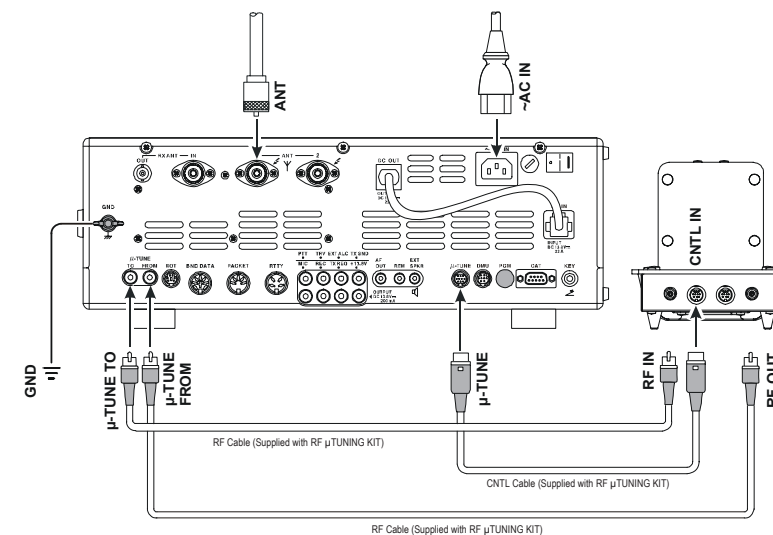

### ADVICE

- The RF connecting cables are color coded (black and gray) to assist in properly connecting the RF IN and RF OUT jacks. (see illustration)
- Miss-connection will not damage the RF μTUNING KIT. However, improper operation may occur.
- Connect the color-coded control cable(s) between the CNTL OUT and CNTL IN jacks (see illustration). Confirm all connections before turning on the transceiver.
- If the **FT-2000** does not operate and the frequency display blinks sometimes, confirm and correct the "CNTL IN" and "CNTL OUT" connections.
- The order of connecting multiple RF μTUNING KITS is not important.

### MULTI CONNECTION

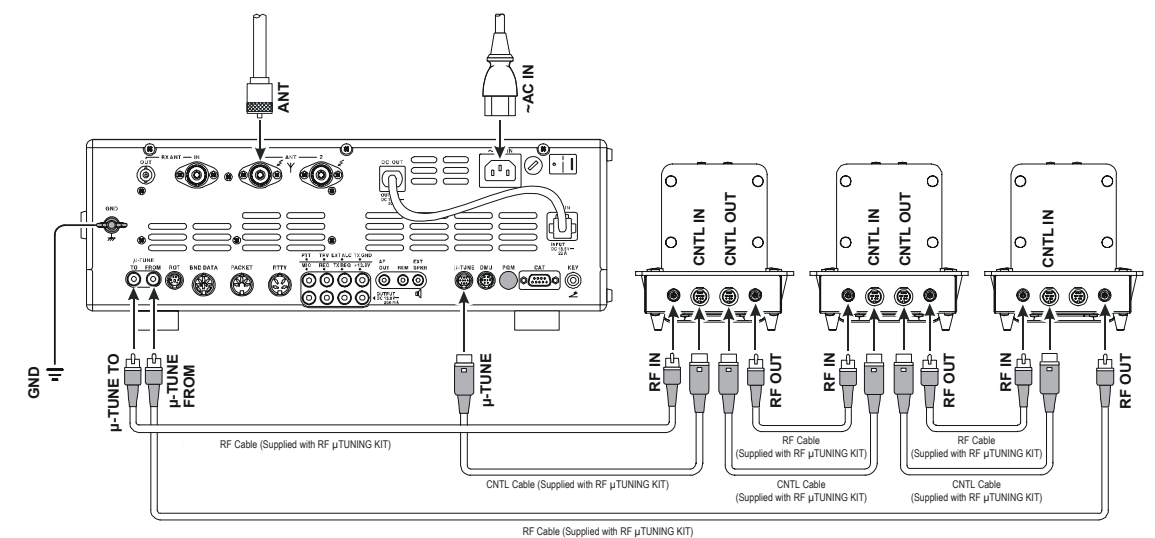

**YAESU**  
Choice of the World's top DX'ers

Copyright 2006  
VERTEX STANDARD CO., LTD.  
All rights reserved

No portion of this manual  
may be reproduced without  
the permission of  
VERTEX STANDARD CO., LTD.

Printed in Japan



## OPERATION

The RF  $\mu$ TUNING KIT provides ultra-sharp RF selectivity for the front end of the transceiver. Very high Q is made possible by the narrow-band design. Three RF  $\mu$ TUNING KITS are available. The MTU-160 covers the 1.8 MHz band. The MTU-80/40 covers the 3.5 and 7 MHz bands. The MTU-30/20 covers 10.1 and 14 MHz bands.

When any (or all) of the three optional units are installed, they will be automatically adjusted to center on your operating frequency.

The narrow bandwidth is especially useful on the low bands, when many strong signals are being received via NVIS propagation (Near Vertical-Incidence Signals) within a narrow bandwidth. The added protection for the RF stage is especially helpful in preventing IMD and blocking.

The RF  $\mu$ TUNING KIT, provides a Q and shape factor much higher than that afforded even by VRF. It can also be manually adjusted to provide relief from interference as close as 10 kHz away. The insertion loss of the RF  $\mu$ TUNING KIT is higher than that of the VRF circuit, so if Noise Figure is a concern you may select the VRF circuit, instead of RF  $\mu$ TUNING KIT, via the Menu of the **FT-2000** transceiver.

1. Press the **[VRF]** button momentarily. The " **$\mu$ -TUNE**" icon will appear at the FLT column of the Receiver Configuration Indicator on the FT-2000 display, and the  $\mu$ -Tune circuit will be engaged.

- The  $\mu$ -Tune circuit will automatically align itself to your operating frequency.

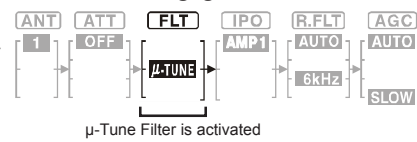

- The VRF circuit will engage when you choose an amateur band which is not connected to a  $\mu$ -TUNE UNIT.

2. Now rotate the **[VRF]** knob to peak the response (background noise) or reduce interference.

- You may observe the relative peak point of the  $\mu$ -Tune filter in the Tuning Offset Indicator on the display while tuning the **[VRF]** knob.

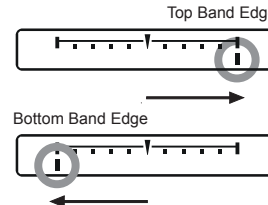

- The amount of change in the center frequency of the  $\mu$ -Tune filter, when rotating the **[VRF]** knob by one click, can be configured using Menu item "**035 GEN E  $\mu$ T DIAL**."

3. Press the **[VRF]** button (momentarily) once more to disengage the  $\mu$ -Tune filter. The "**THRU**" icon will turn on in place of "**VRF**" icon. In this mode, only the fixed bandpass filter for the current band will be engaged.

### ADVICE

- The  $\mu$ -Tune filters are the most advanced, selective RF preselector filters ever incorporated into an Amateur Radio transceiver. The RF selectivity provided by  $\mu$ -Tune can be of tremendous value in ensuring quiet, intermod-free reception even in the most crowded bands on a contest weekend. The  $\mu$ -Tune filters provide RF selectivity on the order of a few dozen kHz at -6 dB, at the expense of a few dB of system gain on bands where noise figure is seldom an issue. You will notice that the S-meter deflection, when  $\mu$ -Tune is engaged, is slightly less than when it is out of the circuit. This is normal. If your antenna system gain is so low that it is impossible to hear band noise when  $\mu$ -Tune is engaged (highly unlikely), just switch it out or revert to the VRF system, which has slightly less insertion loss.
- As you tune around on an amateur band with  $\mu$ -Tune engaged, the microprocessor automatically commands the stepper motor to drive the toroid core stack and center the filter on your current operating frequency (the tuning resolution is 5 kHz). You may, however, use the **[VRF]** knob to skew the filter response to one side or the other of your operating frequency, to deal with heavy interference on either side. To re-center the  $\mu$ -Tune filter on the operating frequency, and eliminate any offset, press and hold in the **[VRF]** switch for two seconds.
- You can use the  $\mu$ -Tune circuit on the Sub Band Receiver (VFO-B). However, in this case, the stepper motor does not drive the toroid core to center the filter on your operating frequency. You must adjust the peak response (background noise) or reduce interference by rotating the **[VRF]** knob.
- You may always observe the peak point of the  $\mu$ -Tune filter in the Tuning Offset Indicator on the display via Menu item "**010 diSP BAR SEL**."
- While  $\mu$ -Tune is a superior RF preselection circuit, it may be disabled via the Menu on the **FT-2000**; if this is done, the VRF circuit will engage when the **[VRF]** button is pressed. To disable  $\mu$ -Tune, enter the Menu item "**035 GEN E  $\mu$ T DIAL**" of the **FT-2000** then set the selection to "OFF."

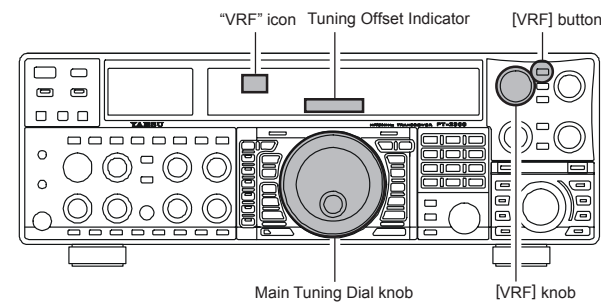

### QUICK NOTE

The permeability-tuning concept utilized in the  $\mu$ -Tune circuit dates back many decades, as it was incorporated in such classic transceivers as the **FT-101** and **FT-901** series, in addition to the **FT dx 401** and similar models. The  $\mu$ -Tune circuit in this RF  $\mu$ TUNING KIT is the highest development of this circuit concept ever employed in an Amateur transceiver, and is adopted in our highest-grade transceiver **FT dx 9000** series.

## $\mu$ -TUNE AND VRF: COMPARISONS TO FIXED BANDPASS FILTERS

### $\mu$ -Tune

Inspection of the illustrations to the right will demonstrate the profound advantage of the  $\mu$ -Tune circuit. In illustration **[A]**, the gray area represents the passband of a typical fixed bandpass filter covering the 1.8 ~ 3 MHz range; this is typical of the kind of bandpass filter found in many high-quality HF receivers today. Note also the hypothetical distribution of signals across the 160-meter band.

In illustration **[B]**, note the narrow white segment within the gray passband of the fixed BPF. These narrow segments represent the typical bandwidth of the  $\mu$ -Tune filter, and one can see that the passband has been reduced from about 750 kHz in the case of the fixed BPF to a few dozen kHz when  $\mu$ -Tune is engaged. The vast majority of the incoming signals are outside the passband of the high-Q  $\mu$ -Tune filter, and they will not impinge on any of the RF/IF amplifiers, the mixers, or the DSP. Very strong out-of-band signals like this can cause Intermodulation, blocking, and an elevated noise floor for a receiver.

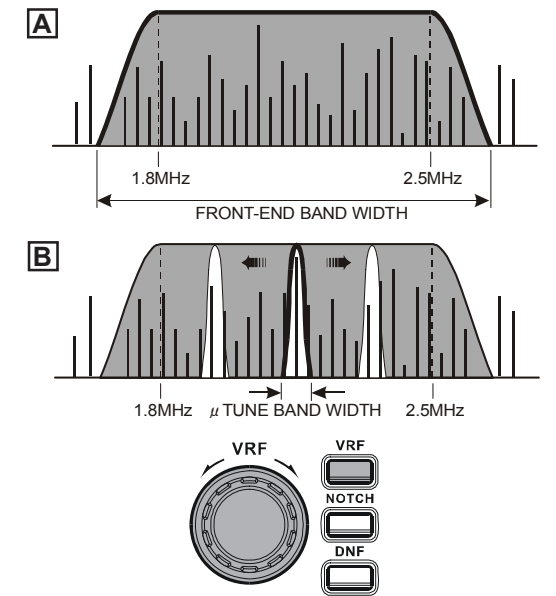

### VRF

In this example, illustration **[a]** depicts a typical fixed bandpass filter covering 14.5 to 22 MHz, and once again the gray shaded area depicts the fixed bandpass filter's frequency coverage. The vertical lines in the illustration represent hypothetical signals throughout this frequency range. Figure **[b]** shows the same fixed BPF, with the white area representing the typical passband of the VRF filter operating in the same frequency range. Although the selectivity of the VRF is not as tight as that of the  $\mu$ -Tune filter, the RF selectivity of the VRF preselector is still magnitudes better than that of the usual fixed bandpass filter, affording significant protection against the ingress of high signal voltage from strong out-of-band signals.

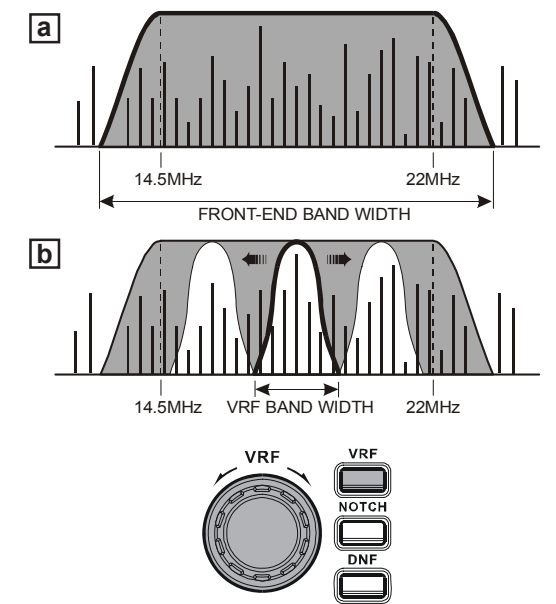

### ADVICE

With  $\mu$ -Tuning, the center frequency of the filter is continuously adjustable throughout its operating range. The quality L/C components ensure high Q of the circuit and a tight passband. The RF preselection design task required the selection of quality L/C components, but the crafting of a tuning mechanism and tuning concept that preserves system Q while providing consistent smooth automated tuning over a wide operating frequency range. The smooth tuning is achieved by varying the inductance over a wide range; this is accomplished by motor-driving a large 1.1" (28 mm) ferrite core stack through a 2" high (50 mm) coil structure. The Q of the  $\mu$ -Tune circuit is over 300, and yields unmatched RF selectivity for outstanding rejection of undesired signals.

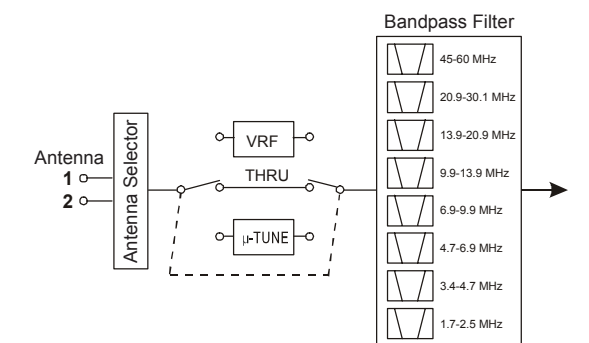

## SPECIFICATIONS

**Case Size (WxHxD):** 4.7" x 5" x 12.9" (120 x 127 x 328 mm)  
**Weight (Approx.):** 5.7 lbs (2.6 kg)